

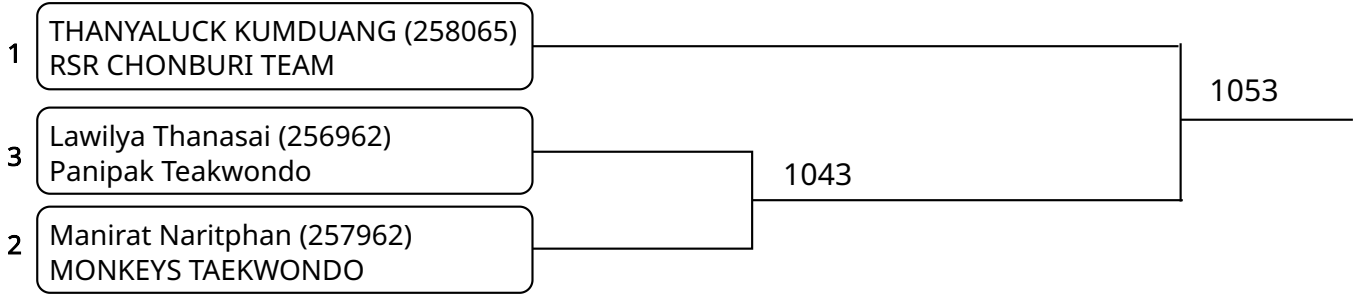

Kyorugi B 12-14Yrs Female 37-41kg G1 (entries: 3)

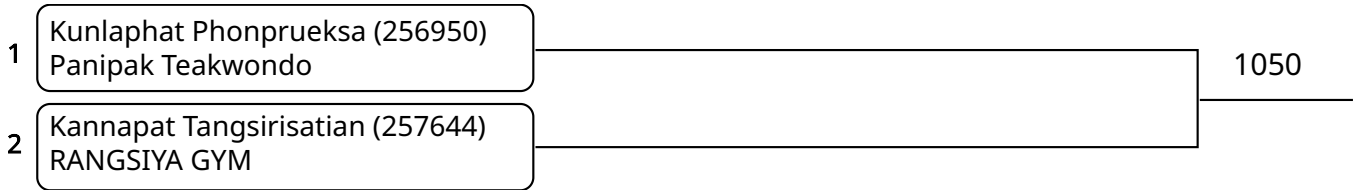

Kyorugi B 12-14Yrs Female 37-41kg G2 (entries: 2)



Kyorugi B 12-14Yrs Female 41-44kg (entries: 3)

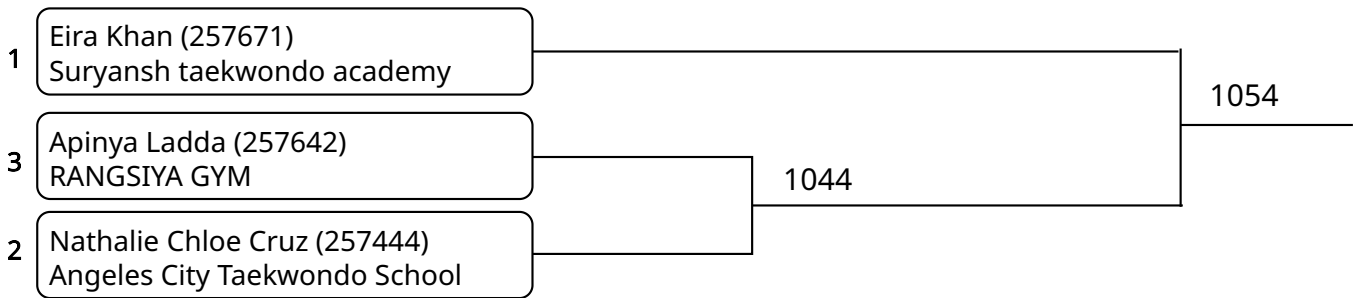

Kyorugi B 12-14Yrs Female 44-47kg (entries: 2)

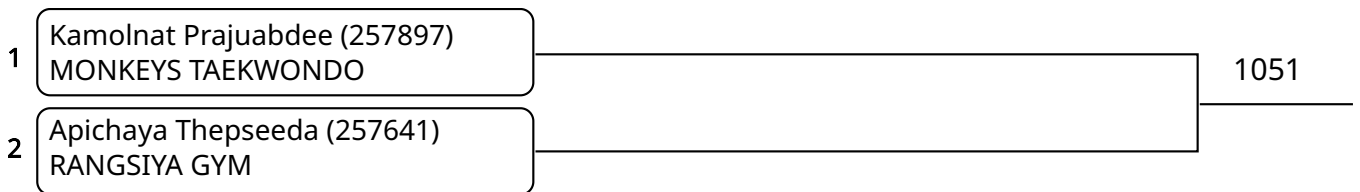

Kyorugi B 12-14Yrs Female 47-51kg (entries: 4)

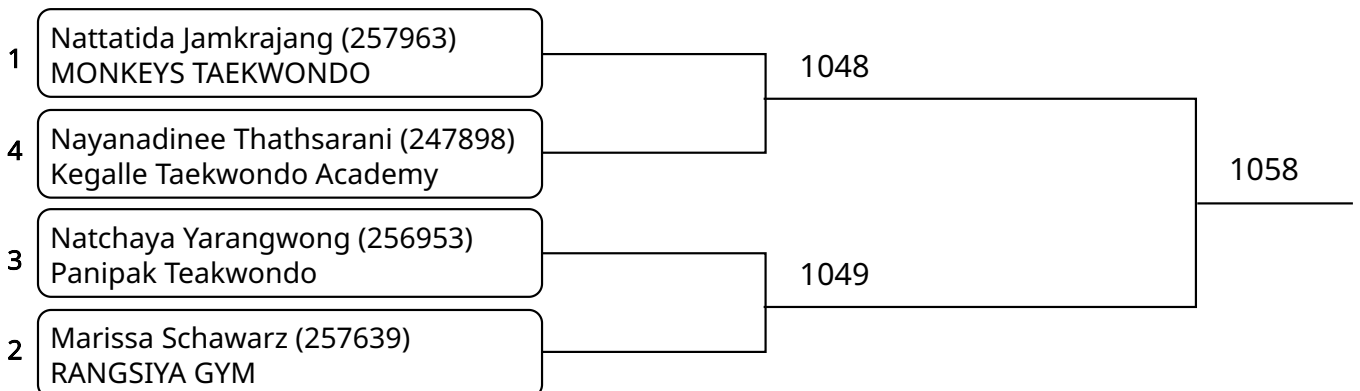



Kyorugi B 12-14Yrs Female 59kg+ (entries: 3)

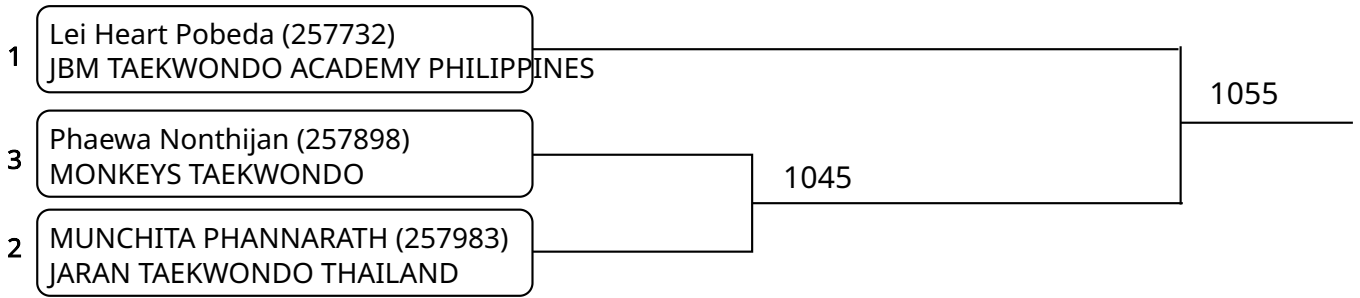

Kyorugi B 12-14Yrs Male 37-41kg (entries: 3)

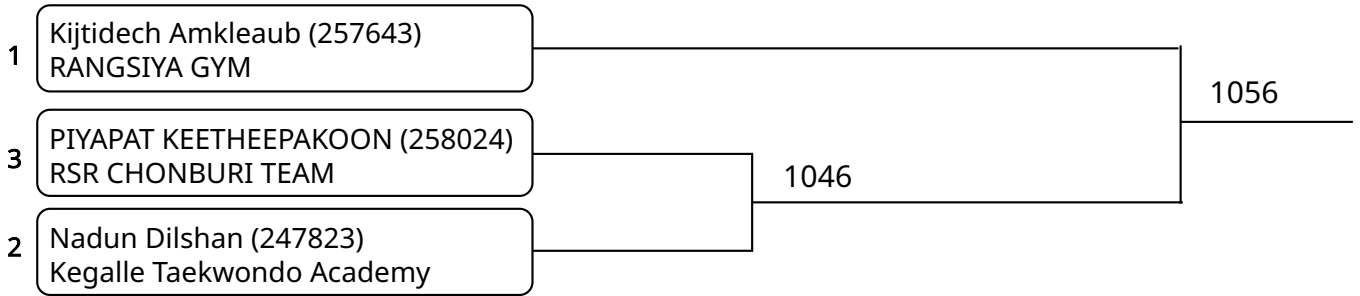

Kyorugi B 12-14Yrs Male 41-45kg (entries: 2)

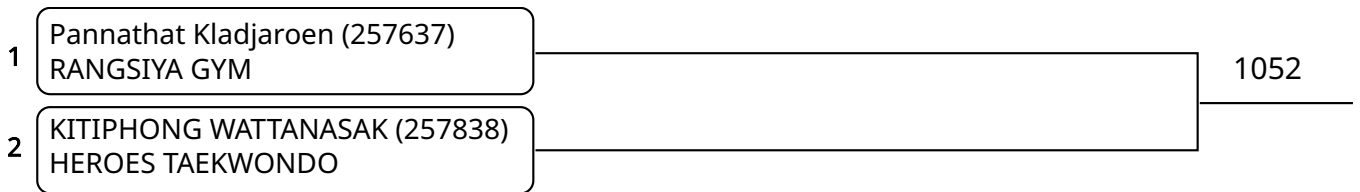

Kyorugi B 12-14Yrs Male 45-49kg (entries: 3)

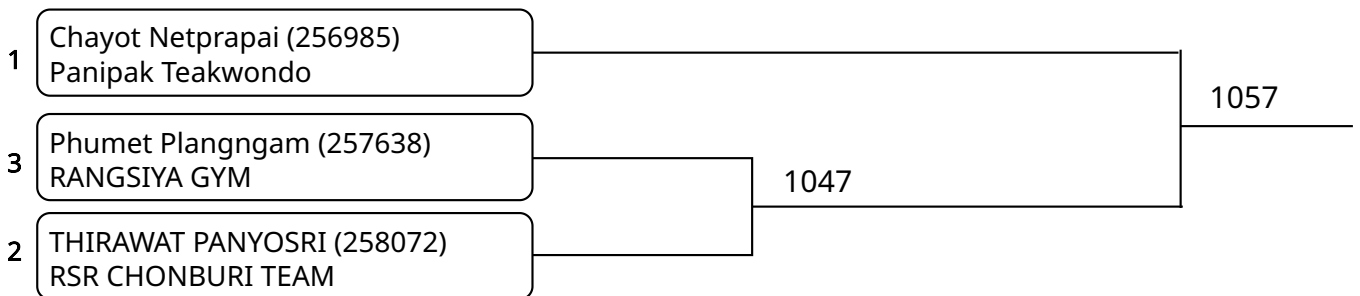

Kyorugi B 5-6Yrs Male -18kg (entries: 3)

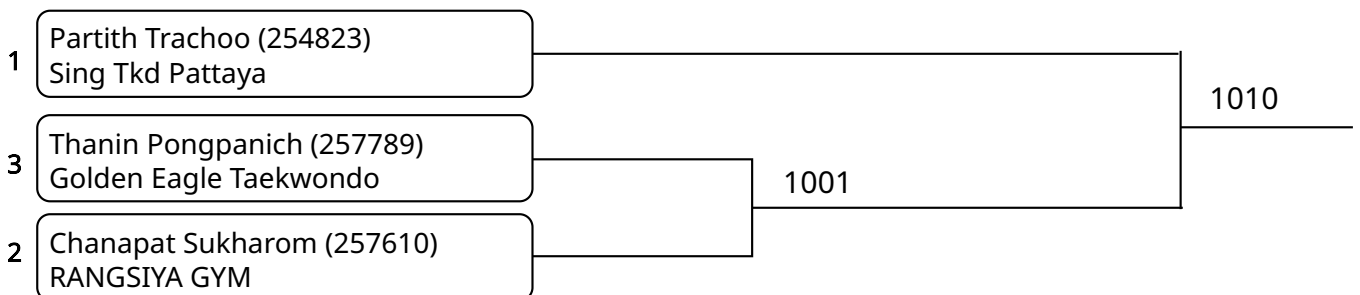



Kyorugi B 7-8Yrs Female -20kg (entries: 4)

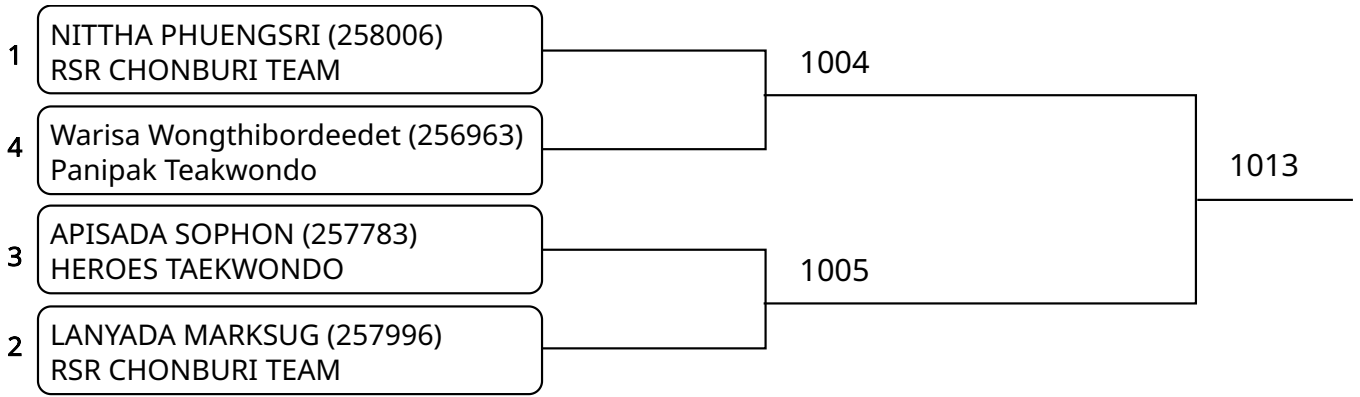

Kyorugi B 7-8Yrs Female 24-27kg (entries: 2)

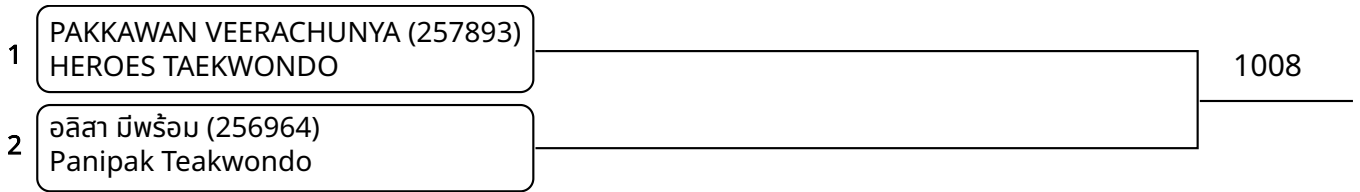

Kyorugi B 7-8Yrs Male -20kg G1 (entries: 3)

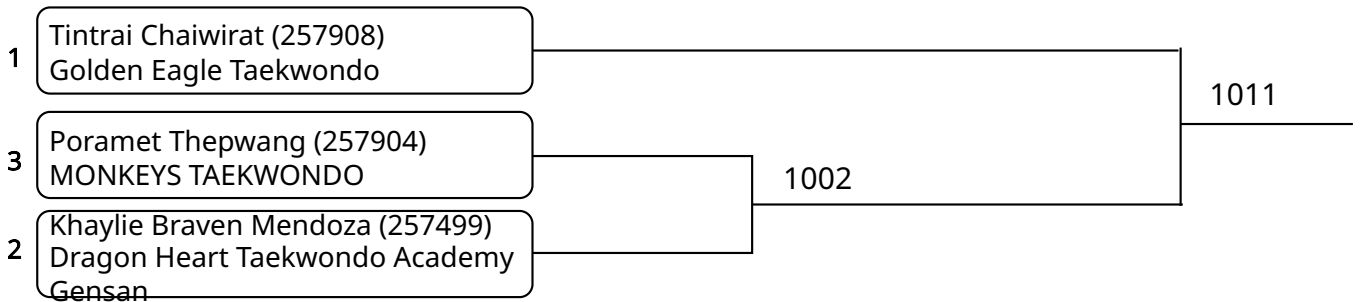

Kyorugi B 7-8Yrs Male -20kg G2 (entries: 2)

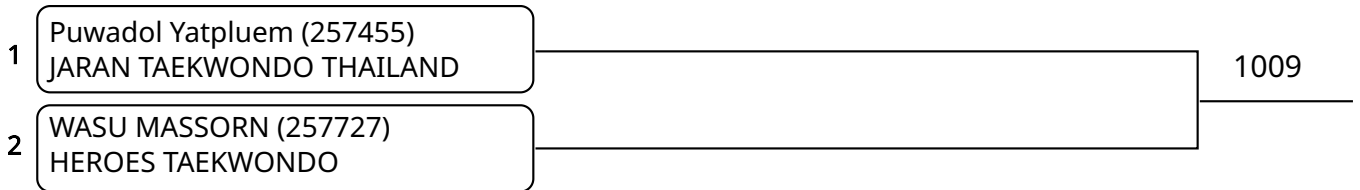

Kyorugi B 7-8Yrs Male 20-22kg (entries: 3)

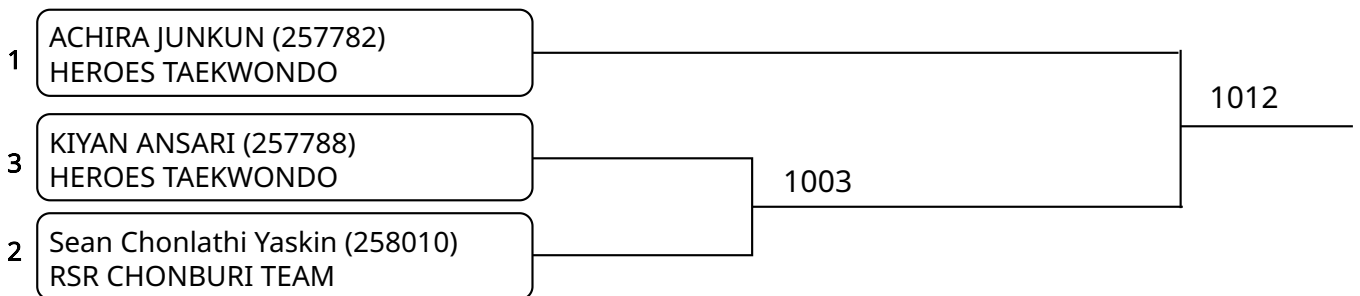



Kyorugi B 7-8Yrs Male 24-27kg (entries: 4)

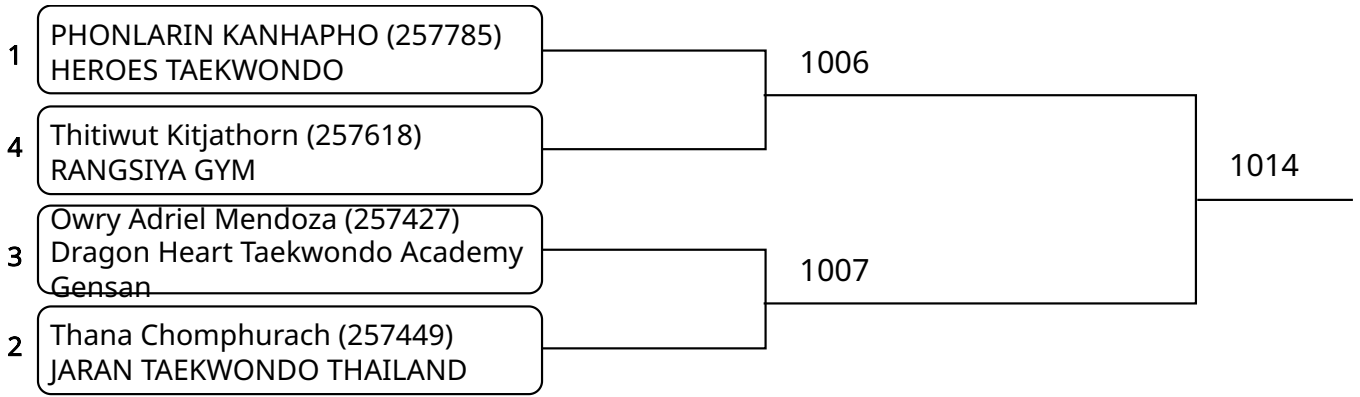

Kyorugi B 9-10Yrs Female -23kg (entries: 4)

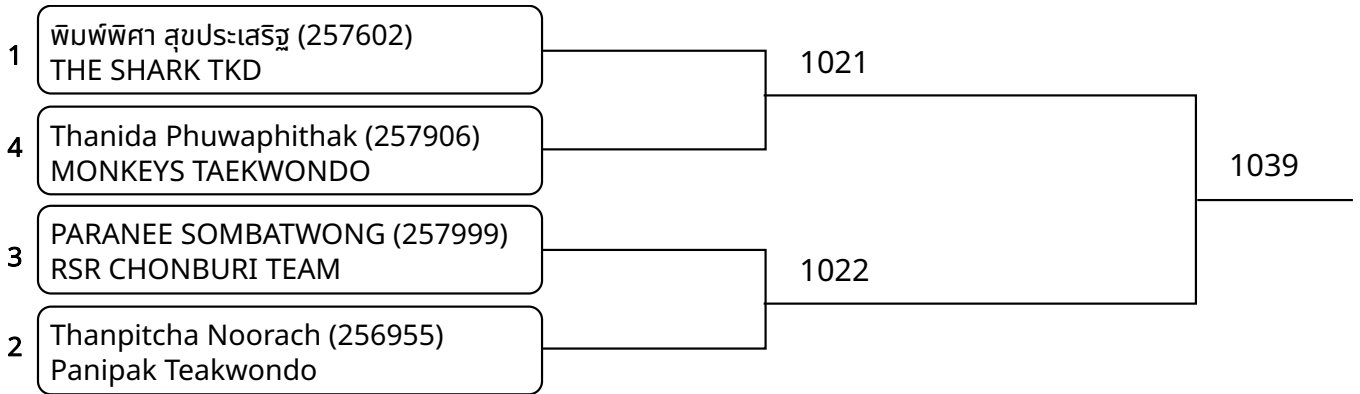

Kyorugi B 9-10Yrs Female 25-27kg (entries: 4)

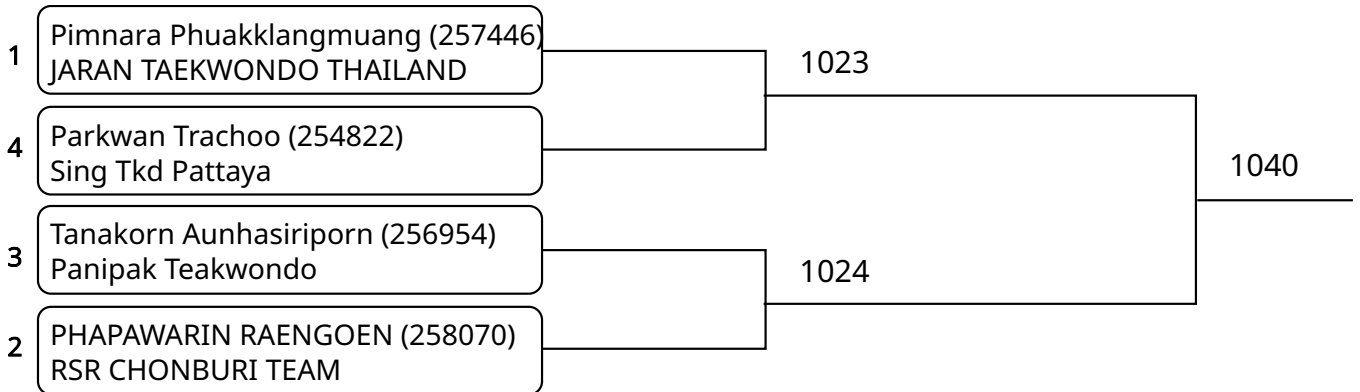

Kyorugi B 9-10Yrs Female 27-29kg (entries: 3)

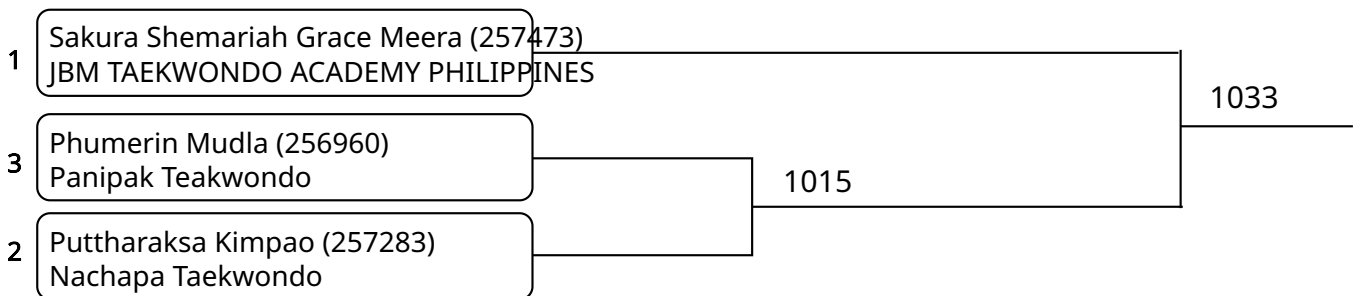



Kyorugi B 9-10Yrs Female 32-36kg (entries: 3)

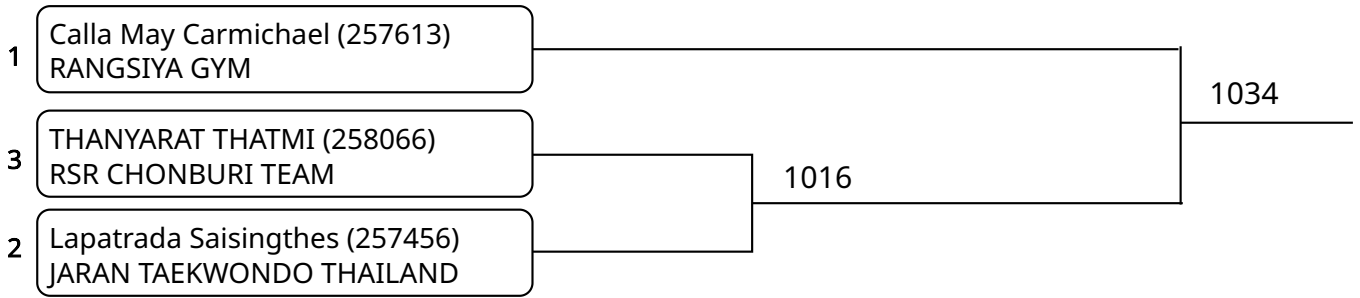

Kyorugi B 9-10Yrs Male -23kg G1 (entries: 4)

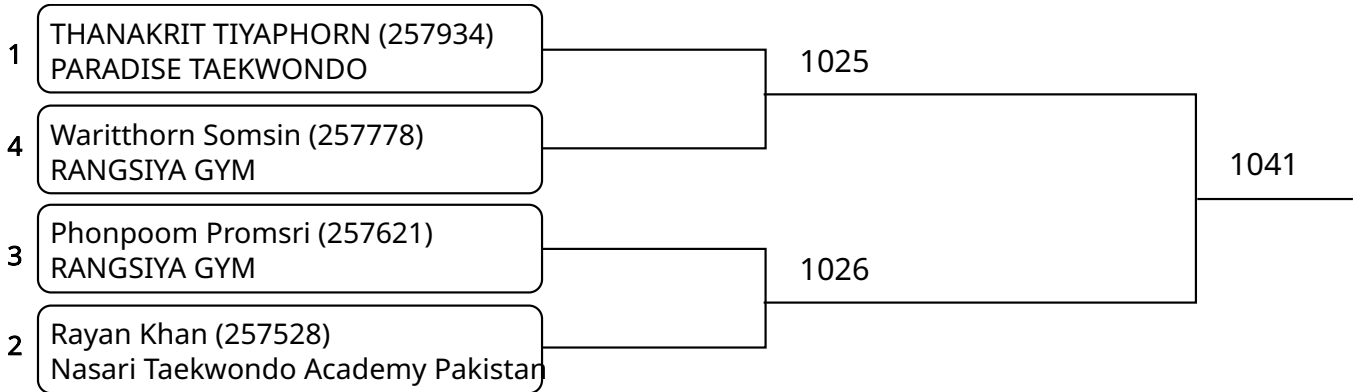

Kyorugi B 9-10Yrs Male -23kg G2 (entries: 3)

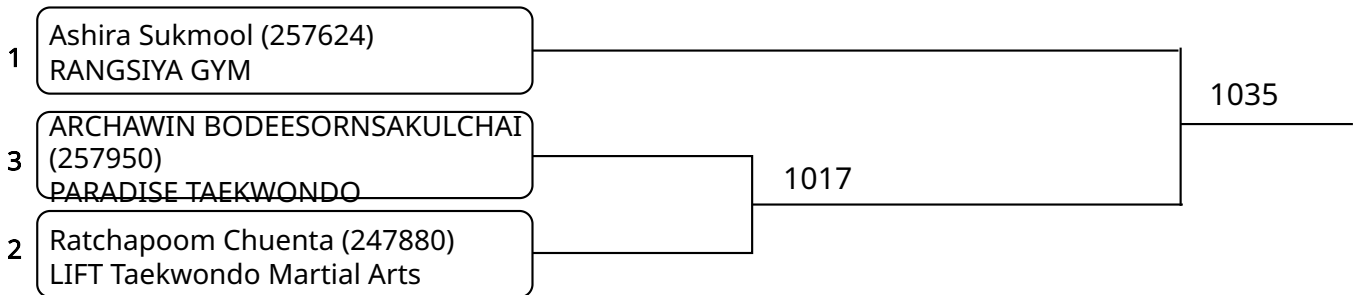

Kyorugi B 9-10Yrs Male 23-25kg G1 (entries: 2)

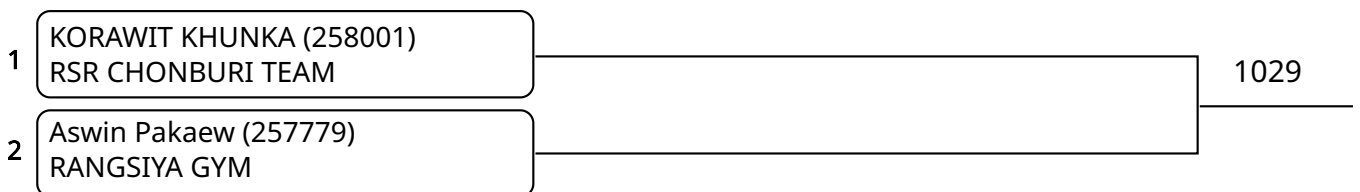

Kyorugi B 9-10Yrs Male 23-25kg G2 (entries: 3)

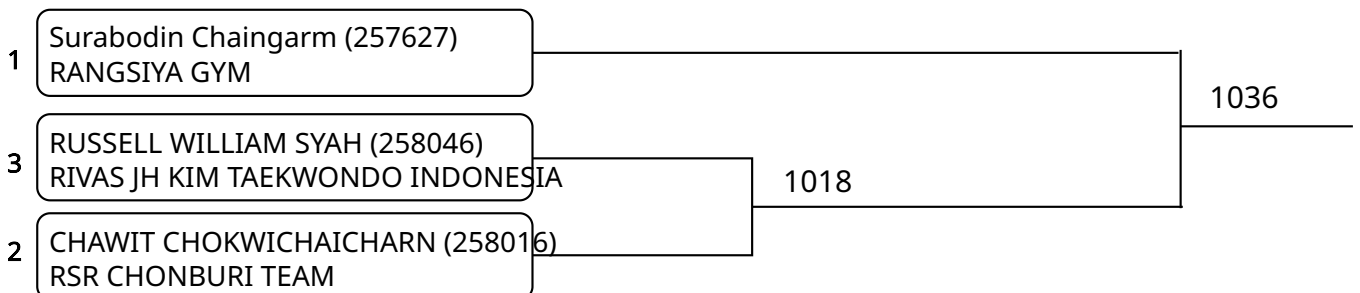



Kyorugi B 9-10Yrs Male 25-27kg (entries: 4)

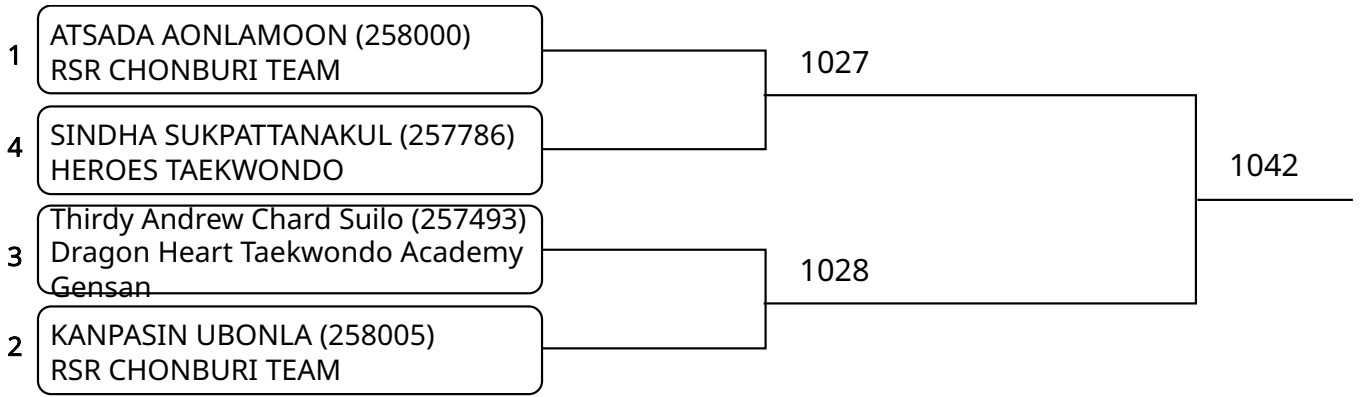

Kyorugi B 9-10Yrs Male 27-29kg (entries: 3)

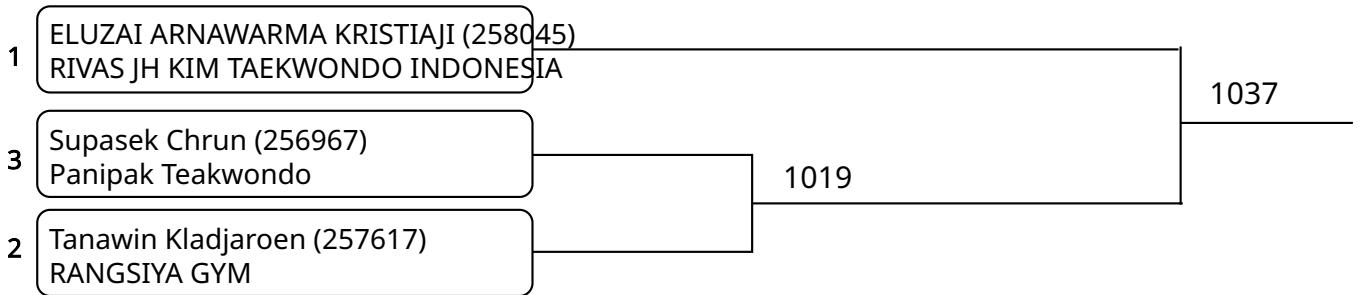

Kyorugi B 9-10Yrs Male 29-32kg G1 (entries: 3)

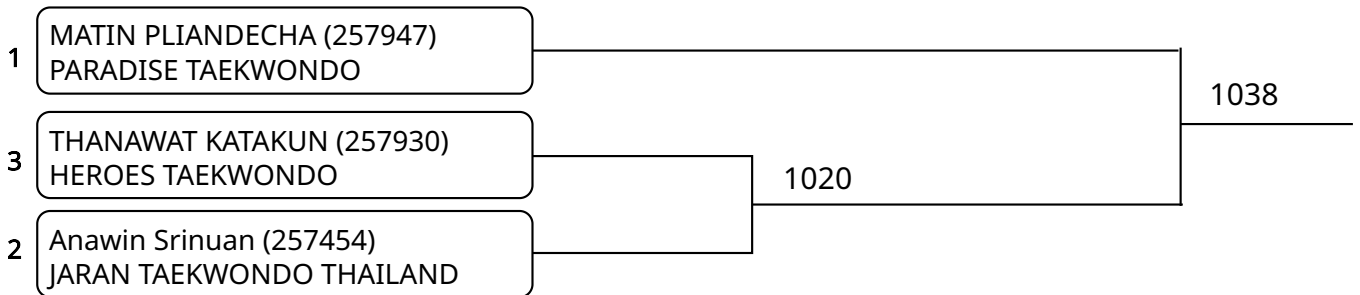

Kyorugi B 9-10Yrs Male 29-32kg G2 (entries: 2)

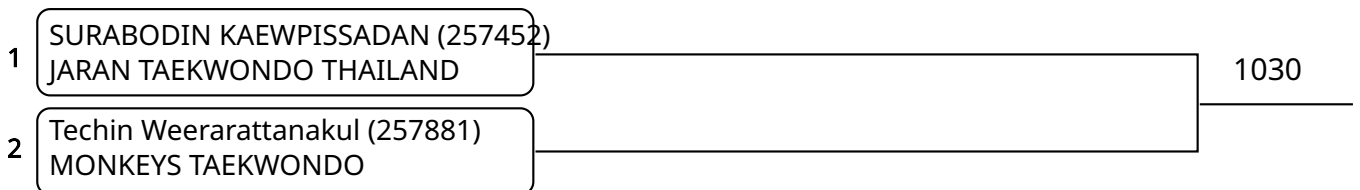

Kyorugi B 9-10Yrs Male 32-36kg (entries: 2)

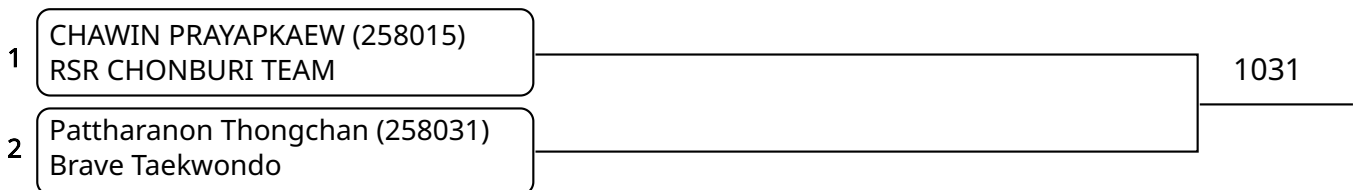



Kyorugi B 9-10Yrs Male 36-40kg (entries: 2)

1	Phil Andrei Chard Suilo (257497) Dragon Heart Taekwondo Academy Gensan	1032
2	KRITSANAPHONG PHONGSIT (257965) HEROES TAEKWONDO	



Kyorugi B 11-12Yrs Female -25kg (entries: 3)

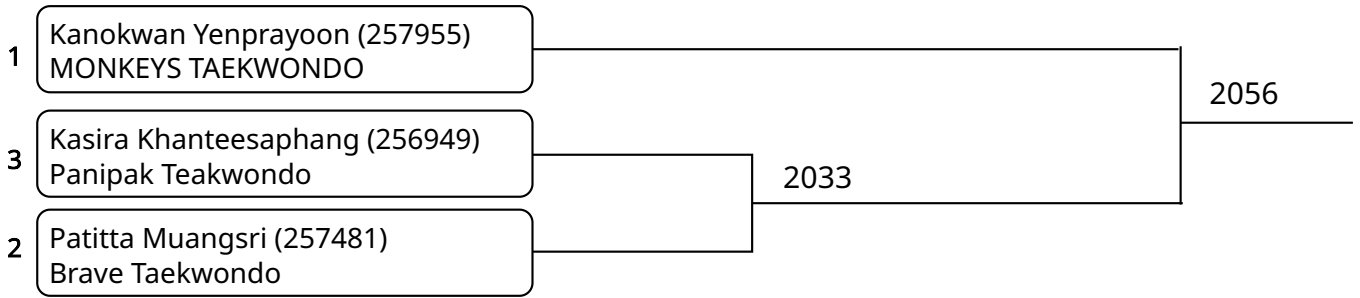

Kyorugi B 11-12Yrs Female 28-31kg G1 (entries: 3)

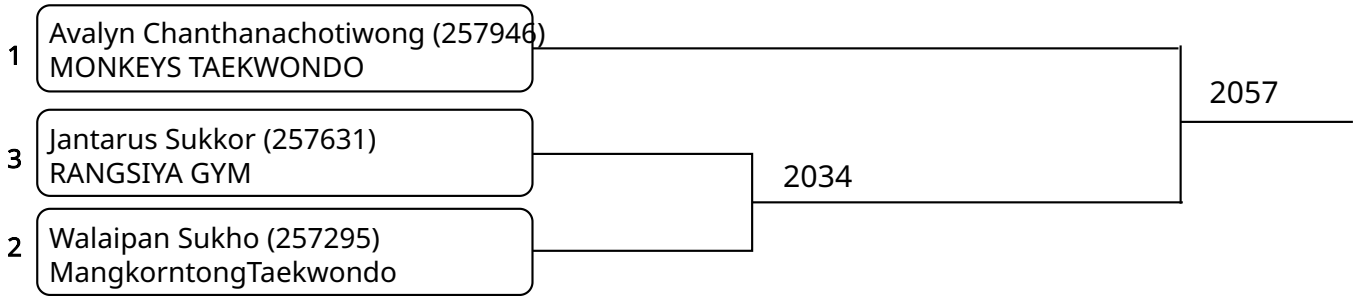

Kyorugi B 11-12Yrs Female 28-31kg G2 (entries: 3)

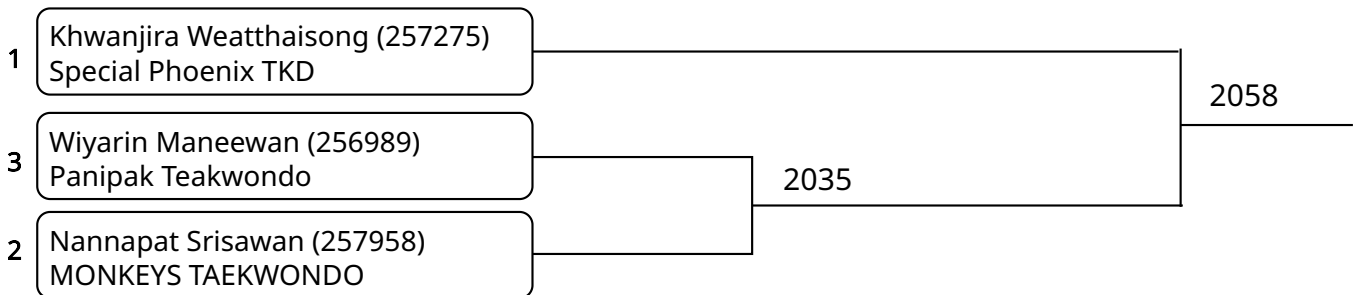

Kyorugi B 11-12Yrs Female 31-34kg (entries: 4)

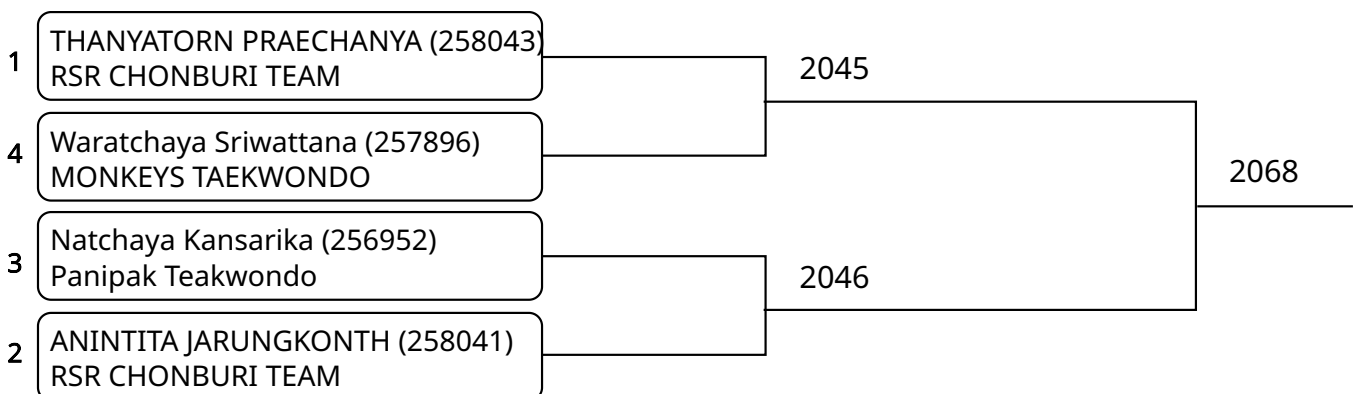



Kyorugi B 11-12Yrs Female 34-38kg G1 (entries: 3)

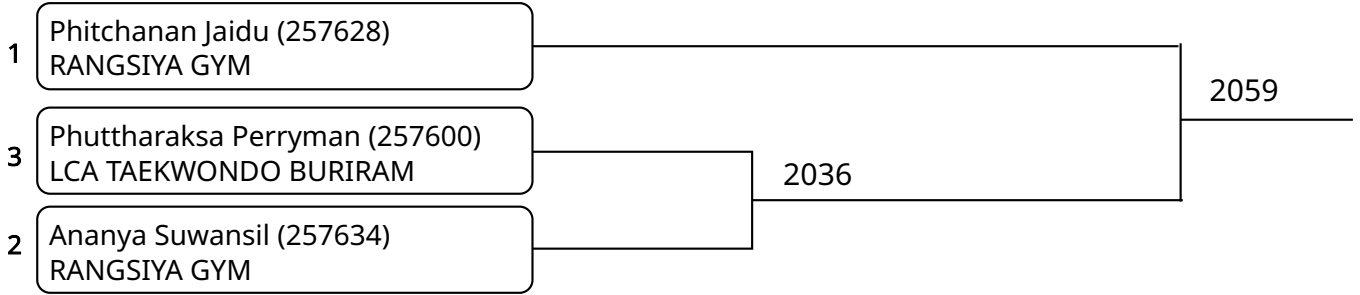

Kyorugi B 11-12Yrs Female 34-38kg G2 (entries: 3)

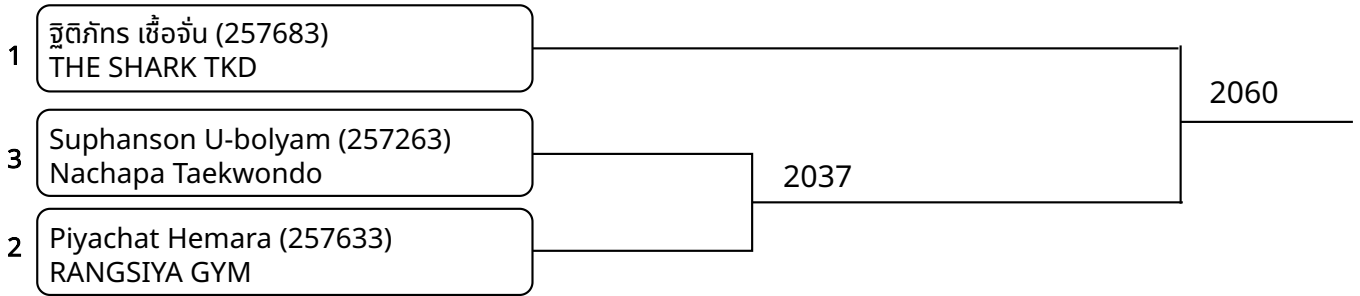

Kyorugi B 11-12Yrs Female 38-42kg (entries: 2)

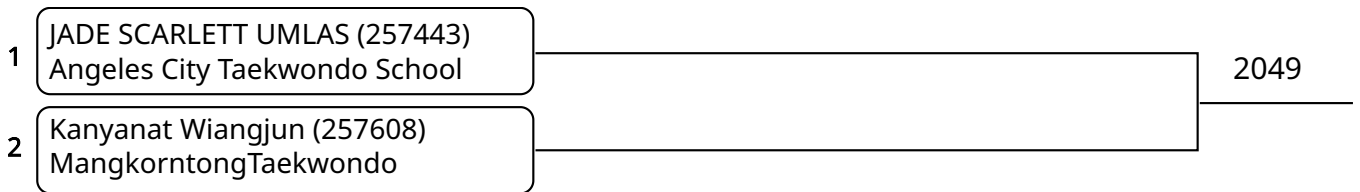

Kyorugi B 11-12Yrs Female 42-46kg (entries: 3)

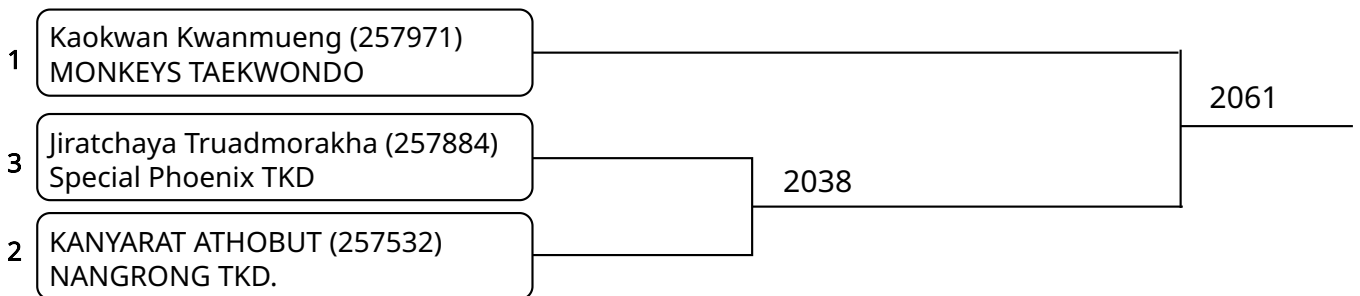

Kyorugi B 11-12Yrs Female 46kg+ (entries: 3)

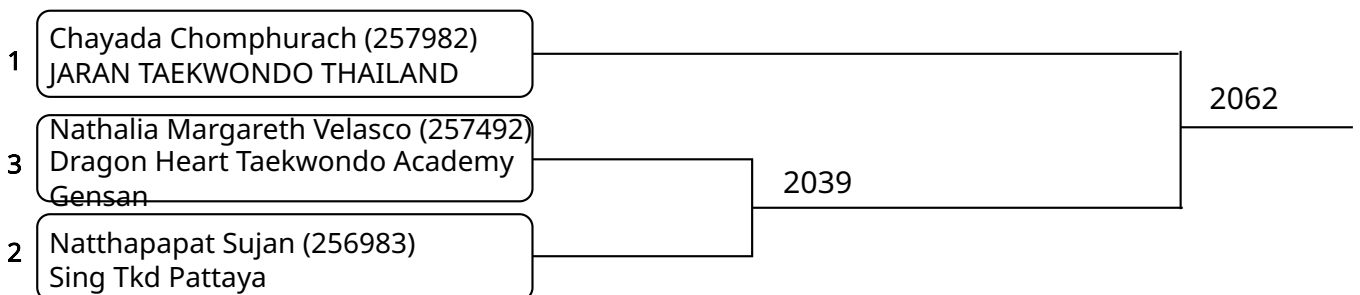



Kyorugi B 11-12Yrs Male -25kg (entries: 2)

1	Kanti Weadthaisong (257885) Special Phoenix TKD	2050
2	Tanapat Somgumlung (257632) RANGSIYA GYM	

Kyorugi B 11-12Yrs Male 25-28kg (entries: 3)

1	TANAKRIT KUEANONGKHUN (257530) NANGRONG TKD.	2063	
3	Thanasap Daithukthang (254833) LCA TAEKWONDO BURIRAM		2040
2	ສົມບູນ ສຸດສະຖາ (257604) THE SHARK TKD		

Kyorugi B 11-12Yrs Male 28-31kg (entries: 3)

1	Plaifa Aemram (257301) MangkorntongTaekwondo	2064	
3	Jirapat Jirachoenwiwat (257956) MONKEYS TAEKWONDO		2041
2	Azlan Khan (257529) Nasari Taekwondo Academy Pakistan		

Kyorugi B 11-12Yrs Male 31-34kg G1 (entries: 3)

1	PANARUN KANHAPHO (257784) HEROES TAEKWONDO	2065	
3	TRIWIT SUDSAINET (257521) NANGRONG TKD.		2042
2	Potchara Plookpoh (256956) Panipak Teakwondo		

Kyorugi B 11-12Yrs Male 31-34kg G2 (entries: 2)

1	Teepakorn Wawmanee (257630) RANGSIYA GYM	2051
2	SONGKLOD SASIWAN (257995) HEROES TAEKWONDO	



Kyorugi B 11-12Yrs Male 34-38kg (entries: 2)

1	Thanetpon Jumpakaew (256924) LIFT Taekwondo Martial Arts	2052
2	PUNNAWIT YUTITHOM (257453) JARAN TAEKWONDO THAILAND	

Kyorugi B 11-12Yrs Male 42-46kg (entries: 2)

1	Kittinun Waiyemittra (257629) RANGSIYA GYM	2053
2	Patcharakorn Wichatorn (257310) LIFT Taekwondo Martial Arts	

Kyorugi B 11-12Yrs Male 46kg+ G1 (entries: 3)

1	Phatthanasan Phonprueksa (256958) Panipak Teakwondo	2066	
3	Kendric Lee Soria (257491) Dragon Heart Taekwondo Academy Gensan		2043
2	Natthakit Pawasan (257277) Special Phoenix TKD		

Kyorugi B 11-12Yrs Male 46kg+ G2 (entries: 3)

1	Jiradej Somboon (257960) MONKEYS TAEKWONDO	2067	
3	Nattarat Jaemjamrat (257278) Special Phoenix TKD		2044
2	Thienrawit Deekum (256965) Panipak Teakwondo		

Kyorugi B 15-17Yrs Female 52-55kg (entries: 4)

1	Wirada Ngoenpam (257964) MONKEYS TAEKWONDO	2069	
4	Nannapas Laungviriyasang (257383) Panipak Teakwondo		2047
3	Leah Jane Fernandez (257474) JBM TAEKWONDO ACADEMY PHILIPPINES		2048
2	Patcharida Kwanta (257645) RANGSIYA GYM		



Kyorugi B 15-17Yrs Male 51-55kg (entries: 2)

1	PHASUT PANPHUM (257909) HEROES TAEKWONDO	2054
2	Kawinchana Sukprasert (257542) LCA TAEKWONDO BURIRAM	

Kyorugi B 15-17Yrs Male 63-68kg (entries: 2)

1	SASAKORN SANQUANPAK (257697) HEROES TAEKWONDO	2055
2	Raka Setiawan (257259) Indonesia Forever Academy	

Kyorugi C 15-17Yrs Female 46-49kg G1 (entries: 2)

1	Duvain Xiannela Rose Suilo (257489) Dragon Heart Taekwondo Academy Gensan	2027
2	Yuki Zakiya Antoinette Mamontayao (257840) Sing Tkd Pattaya	

Kyorugi C 15-17Yrs Female 46-49kg G2 (entries: 3)

1	Phanumast Banthoeng (257328) Nachapa Taekwondo	2029	
3	Phiraya Jaimun (257851) Sing Tkd Pattaya		2023
2	CHANULI RATHNAYAKA (258082) Kegalle Taekwondo Academy		

Kyorugi C 15-17Yrs Female 49-52kg (entries: 2)

1	WANNAKORN NETNOI (258119) SanamChai	2028
2	Minudi Savithmi (247832) Kegalle Taekwondo Academy	

Kyorugi C 15-17Yrs Male 45-48kg (entries: 3)

1	SAJANA OUCHITHYA (258123) Kegalle Taekwondo Academy	2030	
3	WASITH VIHANGA (258089) Kegalle Taekwondo Academy		2024
2	Wachirawat Boonchu (258033) HEROES TAEKWONDO		





Kyorugi C 15-17Yrs Male 48-51kg (entries: 3)

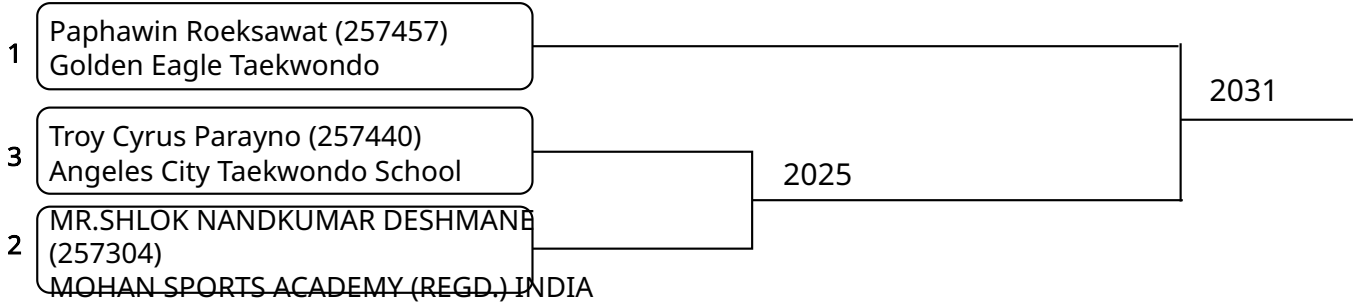

Kyorugi C 15-17Yrs Male 55-59kg (entries: 3)

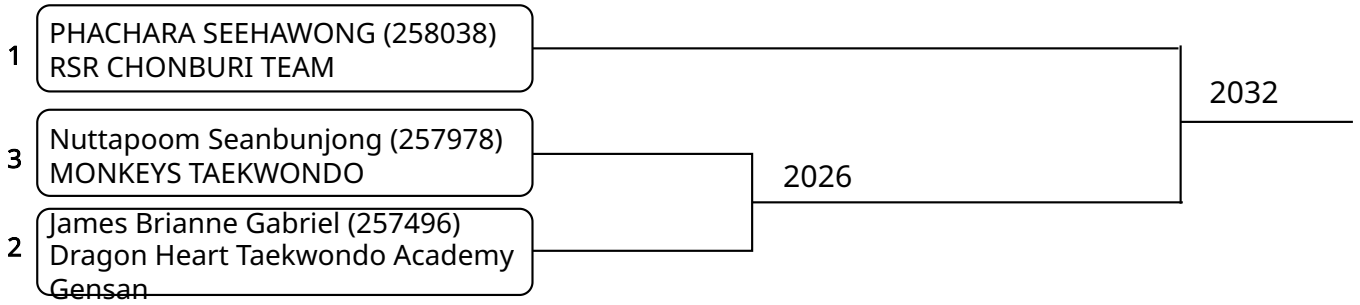

Kyorugi D 9-10Yrs Female -23kg G1 (entries: 3)

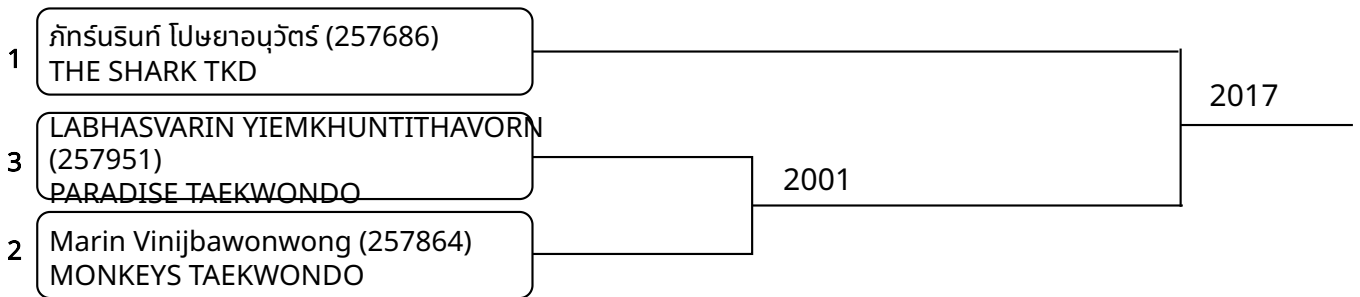

Kyorugi D 9-10Yrs Female 27-29kg (entries: 3)

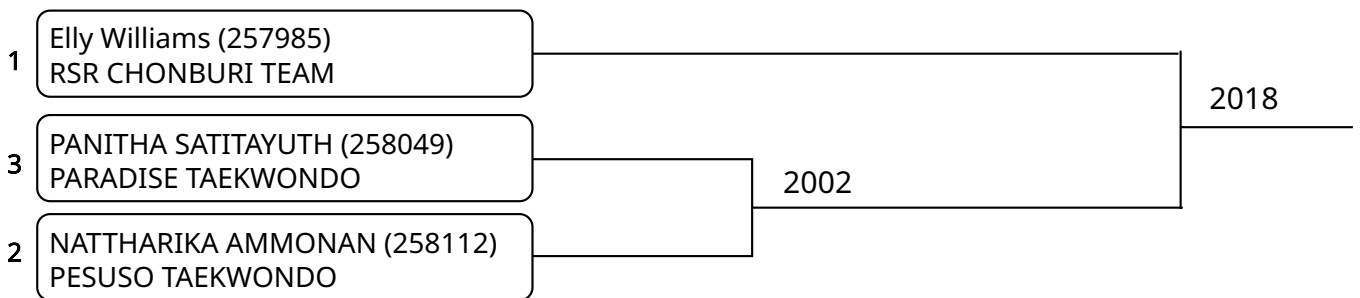

Kyorugi D 9-10Yrs Female 29-32kg G1 (entries: 3)

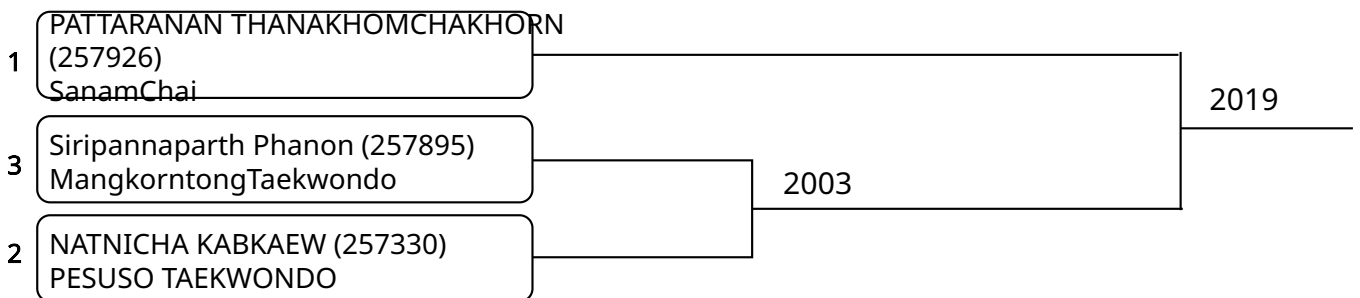



Kyorugi D 9-10Yrs Female 32-36kg (entries: 2)

1	Kansiri Sirikulchayanonta (257577) RSR Taekwondo Sriracha	2007
2	Natpaphat Samanee (258067) THE SHARK TKD	

Kyorugi D 9-10Yrs Male -23kg G1 (entries: 3)

1	BONCHON SINCHERMSIRI (257693) HEROES TAEKWONDO	2020	
3	WINTHAIYA NITIRAKSA (257937) PARADISE TAEKWONDO		2004
2	ณัฐวิมลชัย โพยมอน (257685) THE SHARK TKD		

Kyorugi D 9-10Yrs Male -23kg G2 (entries: 2)

1	Thiraphong Picton (257380) Sing Tkd Pattaya	2008
2	Paphawin Jongjarussang (258047) New Kick Taekwondo	

Kyorugi D 9-10Yrs Male 23-25kg G1 (entries: 2)

1	Pokpong Boonprasop (257366) MangkorntongTaekwondo	2009
2	Jiho Tinnapornpong (257801) HEROES TAEKWONDO	

Kyorugi D 9-10Yrs Male 23-25kg G2 (entries: 2)

1	Dhamkith Seyhiru (247829) Kegalle Taekwondo Academy	2010
2	Atiwit Banluesap (257274) Special Phoenix TKD	

Kyorugi D 9-10Yrs Male 25-27kg G1 (entries: 3)

1	บุญณรัชญ์ แซ่ตัน (257682) THE SHARK TKD	2021	
3	Thakrit Tungjai (257676) New Kick Taekwondo		2005
2	วรศักดิ์ วิณิชบวรวงศ์ (258060) MONKEYS TAEKWONDO		





Kyorugi D 9-10Yrs Male 29-32kg G1 (entries: 2)

1	Phutiwat Boonpog (257563) New Kick Taekwondo	2011
2	OSHEN ELEESHA (247899) Kegalle Taekwondo Academy	

Kyorugi D 9-10Yrs Male 29-32kg G2 (entries: 2)

1	Nattanan Hongvicha (257292) Mangkorntong Taekwondo	2012
2	Wynn Lerdprasertsiri (257787) HEROES TAEKWONDO	

Kyorugi D 9-10Yrs Male 29-32kg G3 (entries: 2)

1	Natthakhun Suwannasut (257592) Dragon King Bowin School	2013
2	Pasith Pueriphanvichai (257818) HEROES TAEKWONDO	

Kyorugi D 9-10Yrs Male 36-40kg G1 (entries: 3)

1	ပဏ္ဍိတ ဗုဒ္ဓဇိမ် (257882) MONKEYS TAEKWONDO	2022	
3	Diego Jose Lacson (257399) Angeles City Taekwondo School		2006
2	Binuth Siri manna (257804) HEROES TAEKWONDO		

Kyorugi D 9-10Yrs Male 36-40kg G2 (entries: 2)

1	NG ZI RYU (258077) RIVAS-JH KIM TAEKWONDO MALAYSIA	2014
2	Naruephak Phakphian (258117) Dragon King Bowin School	

Kyorugi D 9-10Yrs Male 36-40kg G3 (entries: 2)

1	SUHAS NETHSARA (258121) Kegalle Taekwondo Academy	2015
2	ဥဒ္ဓမ္မဝ နီ (257949) MONKEYS TAEKWONDO	





Kyorugi D 9-10Yrs Male 40kg+ (entries: 2)

1	Chawanwit Sangsee (257340) LIFT Taekwondo Martial Arts	2016
2	ชวรินทร์ บุษยยิ่ง (257900) MONKEYS TAEKWONDO	



Kyorugi C 9-10Yrs Female -23kg (entries: 2)

1	NATTHAKANOK CHAROENWONG (258036) RSR CHONBURI TEAM	3056
2	ONNICHA KRATIC (257998) RSR CHONBURI TEAM	

Kyorugi C 9-10Yrs Female 23-25kg G1 (entries: 3)

1	NADDAPORN MASSORN (257728) HEROES TAEKWONDO	3059	
3	Alisa Aksornvate (257850) Sing Tkd Pattaya		3052
2	NARITA BHOKARE (257940) PARADISE TAEKWONDO		

Kyorugi C 9-10Yrs Female 23-25kg G2 (entries: 2)

1	Chalida Niphonram (257363) MangkorntongTaekwondo	3057
2	JADE JESSIE BOURKE (258011) RSR CHONBURI TEAM	

Kyorugi C 9-10Yrs Female 29-32kg (entries: 3)

1	Patarakamol Taengthaing (257494) Nachapa Taekwondo	3060	
3	លីវ្យាត្រីស្រី ធីន្ទរាជ (257596) THE SHARK TKD		3053
2	Pobrak Indradat (257993) RSR CHONBURI TEAM		

Kyorugi C 9-10Yrs Female 36-40kg (entries: 2)

1	Rosina Manners (257680) LCA TAEKWONDO BURIRAM	3058
2	Korrawan Saeju (257576) RSR Taekwondo Sriracha	





Kyorugi C 9-10Yrs Male 23-25kg G1 (entries: 3)

1	Pacharadon Yan (257918) JBK Taekwondo	3061
3	WACHIRAWIT CHEUNG (258028) RSR CHONBURI TEAM	
2	Phawadon Tanatamchokchai (257272) Special Phoenix TKD	

Kyorugi C 9-10Yrs Male 23-25kg G2 (entries: 3)

1	Jiranat Kwangkhwang (257311) LIFT Taekwondo Martial Arts	3062
3	Nattakorn Pongsorn (257716) HEROES TAEKWONDO	
2	Hatthakorn Kantavong (257917) JBK Taekwondo	

Kyorugi D 11-12Yrs Female 25-28kg G1 (entries: 3)

1	YETHULI DINAYA (258088) Kegalle Taekwondo Academy	3048
3	SOPISTHA CHANTO (257416) HEROES TAEKWONDO	
2	Warinrampai Chanted (257952) MONKEYS TAEKWONDO	

Kyorugi D 11-12Yrs Female 25-28kg G2 (entries: 2)

1	BINULI RANAYA (258078) Kegalle Taekwondo Academy	3040
2	ไพรากรณ์ วงศ์ศิริรัตน์ (257970) MONKEYS TAEKWONDO	

Kyorugi D 11-12Yrs Female 25-28kg G3 (entries: 2)

1	Chularat Boonpog (257553) New Kick Taekwondo	3041
2	KHEMJEERAT PHALANISONG (258040) RSR CHONBURI TEAM	



Kyorugi D 11-12Yrs Female 38-42kg G1 (entries: 3)

1	ฉัญภา พันธุ์สุข (257262) Nachapa Taekwondo	3037	3049
3	Nava Vinijbawonwong (257948) MONKEYS TAEKWONDO		
2	Arisa Promsin (257826) Sing Tkd Pattaya		

Kyorugi D 11-12Yrs Female 38-42kg G2 (entries: 2)

1	ลภัสดา ศักดิ์สุข (257961) MONKEYS TAEKWONDO	3042
2	IRADA NETNEE (257582) New Kick Taekwondo	

Kyorugi D 11-12Yrs Female 38-42kg G3 (entries: 2)

1	Pansa Sriwattana (258027) MONKEYS TAEKWONDO	3043
2	KANTICHA ARANYAPHUM (257331) PESUSO TAEKWONDO	

Kyorugi D 11-12Yrs Male 25-28kg (entries: 3)

1	CHATCHAWAN JUAKWOAN (257420) HEROES TAEKWONDO	3038	3050
3	Phakanan Phumtan (258050) Sing Tkd Pattaya		
2	SANKALPA NADUN (258120) Kegalle Taekwondo Academy		

Kyorugi D 11-12Yrs Male 34-38kg G1 (entries: 3)

1	Jullapong Nakprayoon (257465) Nachapa Taekwondo	3039	3051
3	Phawat Insura (257357) PESUSO TAEKWONDO		
2	พีชชาญ สุขเสริม (257291) MangkorntongTaekwondo		



2026-01-24

Kyorugi D 11-12Yrs Male 38-42kg (entries: 2)

1	JINNAPAT CHIMKLEEB (257337) PESUSO TAEKWONDO	3044
2	THANAWAT BUMRUNGSIN (257936) PARADISE TAEKWONDO	

Kyorugi D 11-12Yrs Male 46kg+ G1 (entries: 2)

1	Phumrachata Phireaa (257315) LIFT Taekwondo Martial Arts	3045
2	Khanakorn Rattanthanakitsakorn (257551) New Kick Taekwondo	

Kyorugi D 11-12Yrs Male 46kg+ G2 (entries: 2)

1	พรกวิษย์ ศรีจันทร์ตรา (257598) THE SHARK TKD	3046
2	Wanchana Bhunying (257959) MONKEYS TAEKWONDO	

Kyorugi D 12-14Yrs Female 47-51kg (entries: 2)

1	Pehara Kavithma (247834) Kegalle Taekwondo Academy	3047
2	Sethuni Akithma (247830) Kegalle Taekwondo Academy	

Kyorugi D 7-8Yrs Female -20kg G1 (entries: 2)

1	KANLAYA AMPAPHOL (258075) HEROES TAEKWONDO	3007
2	Primprapa Wawmanee (257620) RANGSIYA GYM	

Kyorugi D 7-8Yrs Female -20kg G2 (entries: 2)

1	Natthaphat Khongnimit (257319) Sing Tkd Pattaya	3008
2	Kanchaya Tungjai (257574) New Kick Taekwondo	





Kyorugi D 7-8Yrs Female 20-22kg G1 (entries: 3)

1	Kanyakorn Meungbun (257400) Sing Tkd Pattaya	3030
3	Pacharapan Kwanmueng (257866) MONKEYS TAEKWONDO	
2	Anastasia Jasmine Hunter (257625) RANGSIYA GYM	

Kyorugi D 7-8Yrs Female 20-22kg G2 (entries: 2)

1	ปภาดา เสริมศรีเดช (257597) THE SHARK TKD	3009
2	Wipawee Chaijanthuek (258068) MONKEYS TAEKWONDO	

Kyorugi D 7-8Yrs Female 22-24kg G1 (entries: 3)

1	เบญจกัญจน์ ทองศรี (257969) MONKEYS TAEKWONDO	3031
3	ANYARIN CHEEWINCHALERMCHOT (257929) HEROES TAEKWONDO	
2	PANYAPORN NUNTASRI (257927) SanamChai	

Kyorugi D 7-8Yrs Female 24-27kg (entries: 2)

1	Rajjira Sirikulchayanonta (257578) RSR Taekwondo Sriracha	3010
2	Heira Queen Felistine Bendoval (257321) Dragon Heart Taekwondo Academy Gensan	

Kyorugi D 7-8Yrs Female 34-38kg G1 (entries: 3)

1	Putthicha Krasaechay (256984) Sing Tkd Pattaya	3032
3	TANASUP SUPPRADIT (257815) HEROES TAEKWONDO	
2	Sunisa Pansakorn (256841) Dragon King Bowin School	





2026-01-24

Kyorugi D 7-8Yrs Male -20kg G1 (entries: 2)

1	NATCHAPON MAKAWAN (257943) PARADISE TAEKWONDO	3011
2	KRITTANAN WONGKUAN (257413) HEROES TAEKWONDO	

Kyorugi D 7-8Yrs Male -20kg G2 (entries: 2)

1	Teeradon Sonthi (257742) PESUSO TAEKWONDO	3012
2	ANAWIN NONSIRI (257418) HEROES TAEKWONDO	

Kyorugi D 7-8Yrs Male -20kg G3 (entries: 2)

1	Phattanan Phumtan (257819) Sing Tkd Pattaya	3013
2	JIRATHIWAT VORAVIWAT (257709) HEROES TAEKWONDO	

Kyorugi D 7-8Yrs Male -20kg G4 (entries: 2)

1	Tankhun Laipuengthong (257820) Sing Tkd Pattaya	3014
2	Thantanakorn Chaichana (257863) MONKEYS TAEKWONDO	

Kyorugi D 7-8Yrs Male -20kg G5 (entries: 2)

1	ณัชพา มะโอบรรณ (257374) Special Phoenix TKD	3015
2	Nakkawat Jariyasin (257805) HEROES TAEKWONDO	

Kyorugi D 7-8Yrs Male 20-22kg G1 (entries: 3)

1	มาร์คัส กุญรัตน บิลลี่ (257905) MONKEYS TAEKWONDO	3033	
3	Yanapat Boontham (257361) Special Phoenix TKD		3004
2	Natthaphat Phakphian (257548) Dragon King Bowin School		





2026-01-24

Kyorugi D 7-8Yrs Male 20-22kg G2 (entries: 2)

1	Chanakan Chanboonruang (258113) Dragon King Bowin School	3016
2	Teeramat Julaketpotichai (257298) MangkorntongTaekwondo	

Kyorugi D 7-8Yrs Male 20-22kg G3 (entries: 2)

1	AROCHA BOONMARK (257323) HEROES TAEKWONDO	3017
2	Patipan Boonprasop (257367) MangkorntongTaekwondo	

Kyorugi D 7-8Yrs Male 20-22kg G4 (entries: 2)

1	THANADECH WATTANATHAWORN (257933) PARADISE TAEKWONDO	3018
2	TRYN KINGKACHEE (257694) HEROES TAEKWONDO	

Kyorugi D 7-8Yrs Male 20-22kg G5 (entries: 2)

1	Amata Saengsawang (257865) MONKEYS TAEKWONDO	3019
2	NAPAT THANAKHOMCHAKHORN (257924) SanamChai	

Kyorugi D 7-8Yrs Male 22-24kg G1 (entries: 2)

1	Chaturaphan Buangam (257410) MangkorntongTaekwondo	3020
2	บิสิศ สุขเกษม (256836) Dragon King Bowin School	

Kyorugi D 7-8Yrs Male 22-24kg G2 (entries: 2)

1	Insung Tinnapornpong (257803) HEROES TAEKWONDO	3021
2	PHAKKAPONG ONGSAKUNCHOOWONG (257531) NANGRONG TKD.	





Kyorugi D 7-8Yrs Male 22-24kg G3 (entries: 2)

1	Pharitmethar Wongwanichpak (257811) HEROES TAEKWONDO	3022
2	THANAKRIT BUMRUNGSIN (257935) PARADISE TAEKWONDO	

Kyorugi D 7-8Yrs Male 22-24kg G4 (entries: 3)

1	Zayn Sharma (257987) RSR CHONBURI TEAM	3034	
3	Jiaming Hao (258118) Dragon King Bowin School		3005
2	NONTAPAT JITCHANVITIT (257817) HEROES TAEKWONDO		

Kyorugi D 7-8Yrs Male 24-27kg G1 (entries: 2)

1	Sitthinon Steiner (257828) Sing Tkd Pattaya	3023
2	SUKSIAM JALEARNRATSAKUL (258039) RSR CHONBURI TEAM	

Kyorugi D 7-8Yrs Male 24-27kg G2 (entries: 2)

1	Nuengtawan Wannapongbhakdee (257351) Golden Eagle Taekwondo	3024
2	Yodchawin Antoine Pineau (256866) Sing Tkd Pattaya	

Kyorugi D 7-8Yrs Male 24-27kg G3 (entries: 2)

1	Kittikun Kaewluang (257393) LIFT Taekwondo Martial Arts	3025
2	Poon Boonpanya (256988) Sing Tkd Pattaya	

Kyorugi D 7-8Yrs Male 24-27kg G4 (entries: 2)

1	Shayne Leonel Ojala (257402) Angeles City Taekwondo School	3026
2	Jitiphat Pimpakan (257780) RANGSIYA GYM	



Kyorugi D 7-8Yrs Male 27-30kg (entries: 2)

1	Nitit Chanprakon (256874) Sing Tkd Pattaya	3027
2	Surachai Saechow (256834) Dragon King Bowin School	

Kyorugi D 7-8Yrs Male 30-34kg G1 (entries: 3)

1	Jiraphat Hmimae (257299) MangkorntongTaekwondo	3035	
3	Matthean Luke Montejo (257403) Angeles City Taekwondo School		3006
2	Jiryu Sakanoue (258073) RANGSIYA GYM		

Kyorugi D 7-8Yrs Male 38kg+ G1 (entries: 2)

1	Kornankul Tongpluem (257860) MONKEYS TAEKWONDO	3028
2	Eoin Drake Vino (257472) Angeles City Taekwondo School	

Kyorugi D 7-8Yrs Male 38kg+ G2 (entries: 2)

1	Thanakrit Chaiyako (257394) LIFT Taekwondo Martial Arts	3029
2	Thitikorn Saelee (257271) Special Phoenix TKD	

**Kyorugi C 11-12Yrs Female 25-28kg** (entries: 3)

1	Saralchana Okas (257317) LIFT Taekwondo Martial Arts	4057
3	ณัชชาธิภักดิ์ ทิมทอง (257594) THE SHARK TKD	
2	SIRINAPA BOONMARK (257327) HEROES TAEKWONDO	

Kyorugi C 11-12Yrs Female 31-34kg (entries: 2)

1	Sophia De cleen (256980) Sing Tkd Pattaya	4049
2	กรวิทย์ จันวินดี (257690) JBK Taekwondo	

Kyorugi C 11-12Yrs Female 34-38kg G1 (entries: 3)

1	NATTAYAPORN MARIDRAM (257522) NANGRONG TKD.	4058
3	อันเจลา มาเจลาโบ (257606) THE SHARK TKD	
2	Tamonwan Pongsorn (257717) HEROES TAEKWONDO	

Kyorugi C 11-12Yrs Female 34-38kg G2 (entries: 3)

1	Simone Emily Foden (257966) MONKEYS TAEKWONDO	4059
3	Mayu Kwayotha (258062) THE SHARK TKD	
2	NATNICHA JUWIWAT (257580) New Kick Taekwondo	

Kyorugi C 11-12Yrs Female 38-42kg (entries: 2)

1	RUTHAIPHAT SUKHUMVITHAYA (257437) CHURAIRAT BY NEUTRAL	4050
2	KANOKKAN SUDSAINET (257524) NANGRONG TKD.	



Kyorugi C 11-12Yrs Male 34-38kg (entries: 3)

1	Aussadakorn khowphol (257373) LIFT Taekwondo Martial Arts	4060
3	ประวัฒน์ เดชกำแหง (257689) JBK Taekwondo	
2	Stefan Phuriphat Sturmer (257635) RANGSIYA GYM	

Kyorugi C 11-12Yrs Male 46kg+ G1 (entries: 3)

1	Pakorn Promlab (257405) LIFT Taekwondo Martial Arts	4061
3	Chayut Nuttanon (257916) JBK Taekwondo	
2	Jatuphat Sukho (257296) MangkorntongTaekwondo	

Kyorugi C 11-12Yrs Male 46kg+ G2 (entries: 2)

1	THANYAWIT PANYOSRI (258012) RSR CHONBURI TEAM	4051
2	Atsawin Klaeokanrai (257636) RANGSIYA GYM	

Kyorugi C 12-14Yrs Female 33-37kg (entries: 4)

1	Sanuli Vidara (247837) Kegalle Taekwondo Academy	4047
4	Prasanya Sanjali (247835) Kegalle Taekwondo Academy	
3	Natcha Wannaphat (257800) HEROES TAEKWONDO	4048
2	Miheli Anudima (247901) Kegalle Taekwondo Academy	

Kyorugi C 12-14Yrs Female 37-41kg (entries: 2)

1	Chanyanuch Phetrukkha (257781) RANGSIYA GYM	4052
2	Georgina Kelly (257603) LCA TAEKWONDO BURIRAM	



Kyorugi C 12-14Yrs Female 41-44kg (entries: 2)

1	NAPANNOP PHONIN (257523) NANGRONG TKD.	4053
2	Kasandra Lamb (258026) PESUSO TAEKWONDO	

Kyorugi C 12-14Yrs Female 44-47kg (entries: 2)

1	The dara Kithnadee (247838) Kegalle Taekwondo Academy	4054
2	Hasali Methsayuri (247836) Kegalle Taekwondo Academy	

Kyorugi C 12-14Yrs Male 37-41kg (entries: 2)

1	Thanin Waratchariyakun (257541) Siri Enterprise	4055
2	Sirinut Sorrasert (257640) RANGSIYA GYM	

Kyorugi C 12-14Yrs Male 45-49kg (entries: 3)

1	Ezekiel Nate Acosta (257435) Angeles City Taekwondo School	4062	
3	NATTAPAT THEPTHSEP (258037) RSR CHONBURI TEAM		4045
2	Sirus Arthur Folden (258064) MONKEYS TAEKWONDO		

Kyorugi C 12-14Yrs Male 49-53kg (entries: 2)

1	Senuka Nethsanda (258090) Kegalle Taekwondo Academy	4056
2	ອິສັຕະ ເທບຄຳແທງ (257688) JBK Taekwondo	

Kyorugi C 12-14Yrs Male 65kg+ (entries: 3)

1	KHUNCHATT ZARAWD (257344) HEROES TAEKWONDO	4063	
3	ສຸກັກສ ອຸ່ງບຸນີ (257691) JBK Taekwondo		4046
2	Royce Martin Bradford (257401) Angeles City Taekwondo School		





Kyorugi C 5-6Yrs Male -18kg (entries: 2)

1	ATHIPHAT BOONMACHAY (257723) HEROES TAEKWONDO	4027
2	JITTIPAT THOMKHIEW (จิตทิพย์) (257883) PESUSO TAEKWONDO	

Kyorugi C 7-8Yrs Female -20kg (entries: 3)

1	Paritchaya Kaewdondoo (257619) RANGSIYA GYM	4031	
3	CHAWANPAT LAOLA (258035) RSR CHONBURI TEAM		4015
2	Pandharee Thammawattana (256966) Panipak Teakwondo		

Kyorugi C 7-8Yrs Female 20-22kg (entries: 3)

1	NATTHANICHA CHITUDOMSAK (257974) Chaiyaphum Taekwondo Academy Phaya Lae Gym	4032	
3	Thitirat Yenprayoon (257903) MONKEYS TAEKWONDO		4016
2	PIYATHIDA NGIMKHAM (257979) Brave Taekwondo		

Kyorugi C 7-8Yrs Female 24-27kg (entries: 2)

1	Annika Audrey Ante (252746) Dragon Heart Taekwondo Academy Gensan	4028
2	Nichapha Wongsirichayadee (257294) Mangkorntong Taekwondo	

Kyorugi C 7-8Yrs Female 27-30kg (entries: 2)

1	Phimnara Srichantra (258061) THE SHARK TKD	4029
2	Kodchaphan Saeju (257573) RSR Taekwondo Sriracha	



Kyorugi C 7-8Yrs Male 20-22kg G1 (entries: 3)

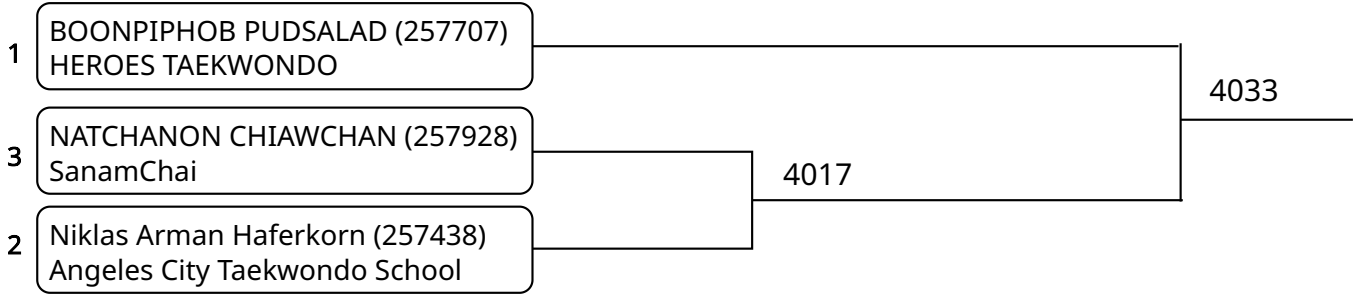

Kyorugi C 7-8Yrs Male 20-22kg G2 (entries: 3)

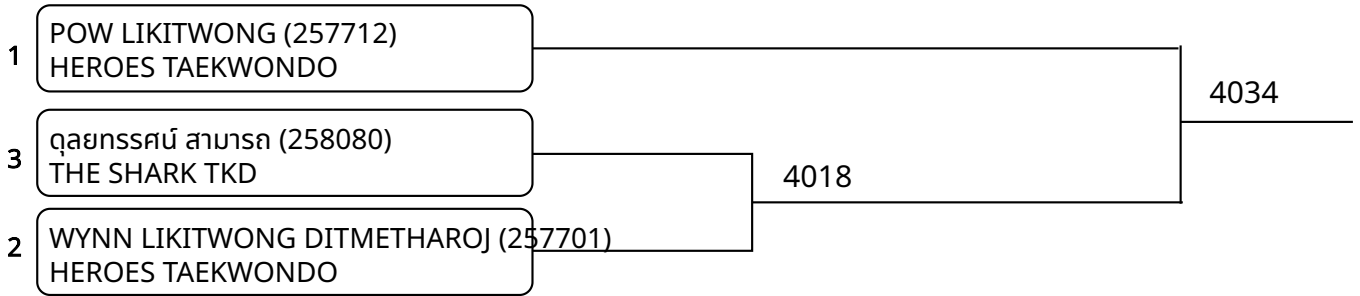

Kyorugi C 7-8Yrs Male 22-24kg (entries: 4)

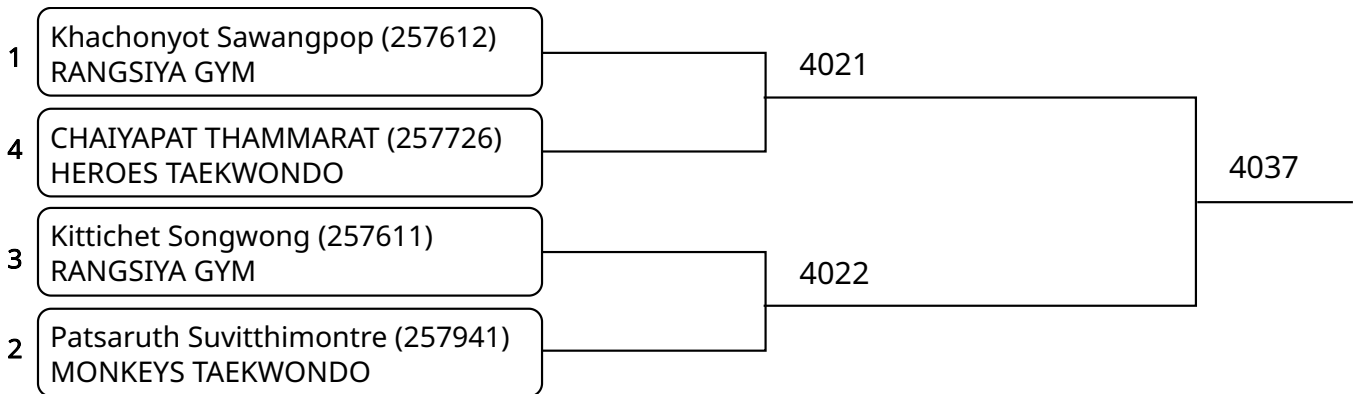

Kyorugi C 7-8Yrs Male 24-27kg (entries: 3)

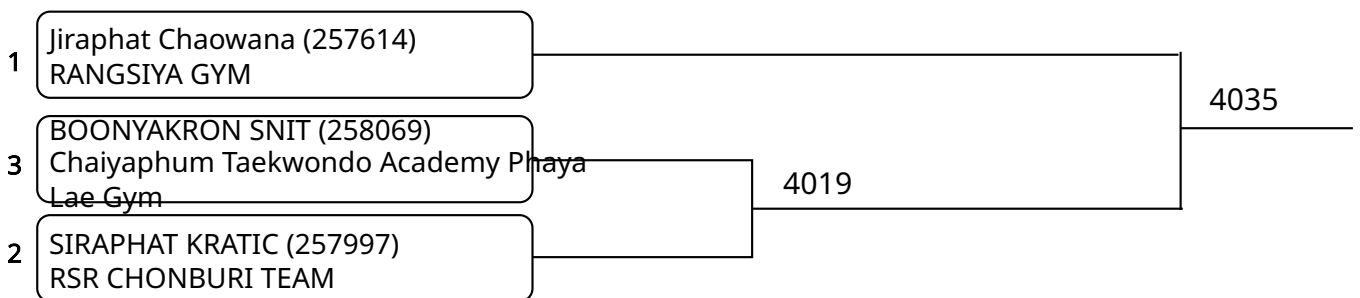

Kyorugi C 7-8Yrs Male 27-30kg (entries: 2)

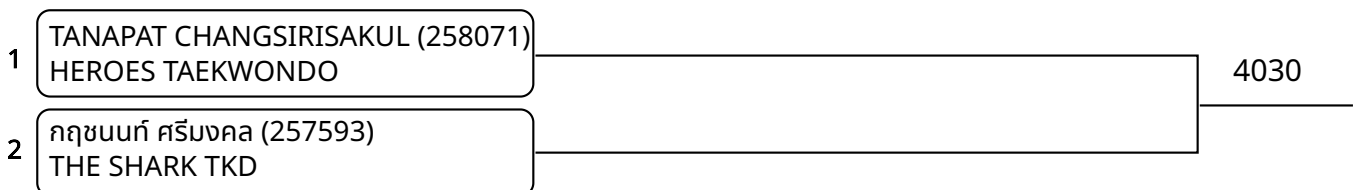



Kyorugi C 9-10Yrs Male 25-27kg (entries: 3)

1	พศิน เต็มสมบูรณ์ (257607) THE SHARK TKD			
3	Chayakrit Chaimang (257293) MangkorntongTaekwondo		4020	
2	กฤษฎิ์ช กัษณะสง (257920) THE SHARK TKD			
				4036

Kyorugi C 9-10Yrs Male 32-36kg (entries: 4)

1	NICKLAS RAVNKILDE (258014) RSR CHONBURI TEAM		4023	
4	krittapas sutuma (257390) Brave Taekwondo			
3	Kaweeakarn Uppasarn (256969) LCA TAEKWONDO BURIRAM		4024	
2	NARUBODIN THAMMARAT (257725) HEROES TAEKWONDO			
				4038

Kyorugi C 9-10Yrs Male 40kg+ (entries: 4)

1	KAWIN TAKOENGPOL (257700) HEROES TAEKWONDO		4025	
4	Peeranat Yoddee (257622) RANGSIYA GYM			
3	Pacharawat Suvisutthimontre (257944) MONKEYS TAEKWONDO		4026	
2	Warinthon Mobundid (257316) LIFT Taekwondo Martial Arts			
				4039

Kyorugi D 3-4Yrs Male 15-18kg G1 (entries: 2)

1	Chalan Tienmanee (257378) Sing Tkd Pattaya			
2	Peniel Wichatorn (257919) JBK Taekwondo			
				4002

Kyorugi D 3-4Yrs Male 15-18kg G2 (entries: 2)

1	Phumiphat Buranavichedkul (257381) Sing Tkd Pattaya			
2	Thirananthana Saodee (257545) Dragon King Bowin School			
				4003





Kyorugi D 5-6Yrs Female -18kg G1 (entries: 2)

1	Phannika Akkrasasikitsakul (257425) MangkorntongTaekwondo	4004
2	Palin Taiyawong (256867) Sing Tkd Pattaya	

Kyorugi D 5-6Yrs Female -18kg G2 (entries: 2)

1	PIMPHITCHA TIYAPHORN (257931) PARADISE TAEKWONDO	4005
2	Nutnaree Shukri (257852) Sing Tkd Pattaya	

Kyorugi D 5-6Yrs Female -18kg G3 (entries: 2)

1	Samantha Camilo (257333) PESUSO TAEKWONDO	4006
2	Worapat Boonyai (258053) Sing Tkd Pattaya	

Kyorugi D 5-6Yrs Female 18-20kg G1 (entries: 3)

1	Jannapas Wannapongbhakdee (257352) Golden Eagle Taekwondo	4014	
3	SMITA CHANTO (257415) HEROES TAEKWONDO		4001
2	Ananya Singh (256876) Sing Tkd Pattaya		

Kyorugi D 5-6Yrs Female 20-22kg (entries: 2)

1	Anyarine Picton (256883) Sing Tkd Pattaya	4007
2	ปรเมต ศึกดีบุรณะกุลชัย (257684) THE SHARK TKD	

Kyorugi D 5-6Yrs Male -18kg G1 (entries: 2)

1	PATIPHAN SATITAYUTH (257932) PARADISE TAEKWONDO	4008
2	Wannuwat Kumlangngam (257359) Golden Eagle Taekwondo	





Kyorugi D 5-6Yrs Male -18kg G2 (entries: 2)

1	Phawat Promjit (257901) MONKEYS TAEKWONDO	4009
2	PHOOMPITCH SORNCHAI (257358) PESUSO TAEKWONDO	

Kyorugi D 5-6Yrs Male -18kg G3 (entries: 2)

1	Sanchirapol Phisutchawarat (257360) Golden Eagle Taekwondo	4010
2	น:๓๓ ๓๓๓๓๓๓๓ (257518) RSR Taekwondo Sriracha	

Kyorugi D 5-6Yrs Male 18-20kg G1 (entries: 2)

1	Ashira Aksornvate (256868) Sing Tkd Pattaya	4011
2	Danil Nekliudov (257992) RSR CHONBURI TEAM	

Kyorugi D 5-6Yrs Male 18-20kg G2 (entries: 2)

1	KARINPAT KITTIPIPATTANATHAWORN (257938) PARADISE TAEKWONDO	4012
2	Nattawat Taenkaew (257382) Sing Tkd Pattaya	

Kyorugi D 5-6Yrs Male 18-20kg G3 (entries: 2)

1	METHA JUAKWOAN (257414) HEROES TAEKWONDO	4013
2	Jayden Kody (258057) Sing Tkd Pattaya	