



Poomsae Individual (A)White Belt 11-12Yrs Male (entries: 1)

1	Azlan Khan (256947) Nasari Taekwondo Academy Pakistan	5008	Winner by Default
---	--	------	-------------------

Poomsae Individual (A)White Belt 5-6Yrs Female (entries: 3)

1	THANAWARAT TIDPROM (258034) HEROES TAEKWONDO	5002	5003
3	Worapat Boonyai (257377) Sing Tkd Pattaya		
2	KOTCHAPHORN INTHASARA (257324) HEROES TAEKWONDO		

Poomsae Individual (A)White Belt 5-6Yrs Male (entries: 1)

1	THEERAPHAT PREMPRAYOONWONGSA (258074) HEROES TAEKWONDO	5001	Winner by Default
---	--	------	-------------------

Poomsae Individual (A)White Belt 7-8Yrs Female (entries: 3)

1	ANYARIN CHEEWINCHALERMCHOT (257915) HEROES TAEKWONDO	5005	5006
3	Rinrada Sachana (257821) HEROES TAEKWONDO		
2	KANLAYA AMPAPHOL (258076) HEROES TAEKWONDO		

Poomsae Individual (A)White Belt 7-8Yrs Male (entries: 2)

1	KRITTANAN WONGKUAN (257421) HEROES TAEKWONDO	5004
2	TANAPAT CHANGSIRISAKUL (257422) HEROES TAEKWONDO	

Poomsae Individual (A)White Belt 9-10Yrs Male (entries: 1)

1	Rayan Khan (257527) Nasari Taekwondo Academy Pakistan	5007	Winner by Default
---	--	------	-------------------





Poomsae Individual (B)Yellow Belt 11-12Yrs Female G1 (entries: 3)

1	Nava Vinijbawonwong (257874) MONKEYS TAEKWONDO	5034
3	NATTAWASA LERTPHATTANASAK (256933) CHURAIRAT BY NEUTRAL	
2	JIRATCHA THOMKHIEW (257338) PESUSO TAEKWONDO	

Poomsae Individual (B)Yellow Belt 11-12Yrs Female G2 (entries: 3)

1	Aphisara Naktong (257942) MONKEYS TAEKWONDO	5036
3	Warinrampai Chanted (257878) MONKEYS TAEKWONDO	
2	Warinrampai Pomsomboon (257812) HEROES TAEKWONDO	

Poomsae Individual (B)Yellow Belt 11-12Yrs Male (entries: 2)

1	CHATCHAWAN JUAKWOAN (257841) HEROES TAEKWONDO	5032
2	Reyansh Bhusal (257468) Prerana Taekwondo Dojang	

Poomsae Individual (B)Yellow Belt 12-14Yrs Female (entries: 1)

1	NUTCHA SAWASDEE (257445) New Kick Taekwondo	5038	Winner by Default
---	--	------	-------------------

Poomsae Individual (B)Yellow Belt 15-17Yrs Female (entries: 2)

1	HAY HYI PATRAI (257335) PESUSO TAEKWONDO	5040
2	CHANULI RATHNAYAKA (258081) Kegalle Taekwondo Academy	

Poomsae Individual (B)Yellow Belt 15-17Yrs Male (entries: 2)

1	James Brianne Gabriel (254788) Dragon Heart Taekwondo Academy Gensan	5039
2	MR.SHLOK NANDKUMAR DESHMANE (257306) MOHAN SPORTS ACADEMY (REGD.) INDIA	





Poomsae Individual (B)Yellow Belt 18Yrs+ Female (entries: 1)

1	HAYAHRONG PATRAI (257334) PESUSO TAEKWONDO	5041	Winner by Default
---	---	------	-------------------

Poomsae Individual (B)Yellow Belt 5-6Yrs Male (entries: 2)

1	อาทิตย์ จันทร์ทอง (257939) MONKEYS TAEKWONDO	5009
2	Natthapong Thongmanee (254811) MangkorntongTaekwondo	

Poomsae Individual (B)Yellow Belt 7-8Yrs Female G1 (entries: 4)

1	Annika Audrey Ante (252747) Dragon Heart Taekwondo Academy Gensan	5016	5018
4	MAYU KAWINTIPPAYAKUL (257556) New Kick Taekwondo	5017	
3	Heira Queen Felistine Bendoval (257495) Dragon Heart Taekwondo Academy Gensan		
2	Kanyakorn Meungbun (257345) Sing Tkd Pattaya		

Poomsae Individual (B)Yellow Belt 7-8Yrs Female G2 (entries: 4)

1	PHITSINEE MANAHAI (257555) New Kick Taekwondo	5019	5021
4	Kwanpitcha Chupayak (257754) Golden Eagle Taekwondo	5020	
3	Celestin June Gabriel (254775) Dragon Heart Taekwondo Academy Gensan		
2	Thitirat Yenprayoon (257870) MONKEYS TAEKWONDO		

Poomsae Individual (B)Yellow Belt 7-8Yrs Male G1 (entries: 4)

1	CHATCHAWEE PATTANAPAISAL (257845) PARADISE TAEKWONDO	5010	5012
4	Patipan Boonprasop (257369) MangkorntongTaekwondo	5011	
3	TRYN KINGKACHEE (257695) HEROES TAEKWONDO		
2	Paraphu Iampiya (257395) FIGHTING FAMILY		





Poomsae Individual (B)Yellow Belt 7-8Yrs Male G2 (entries: 4)

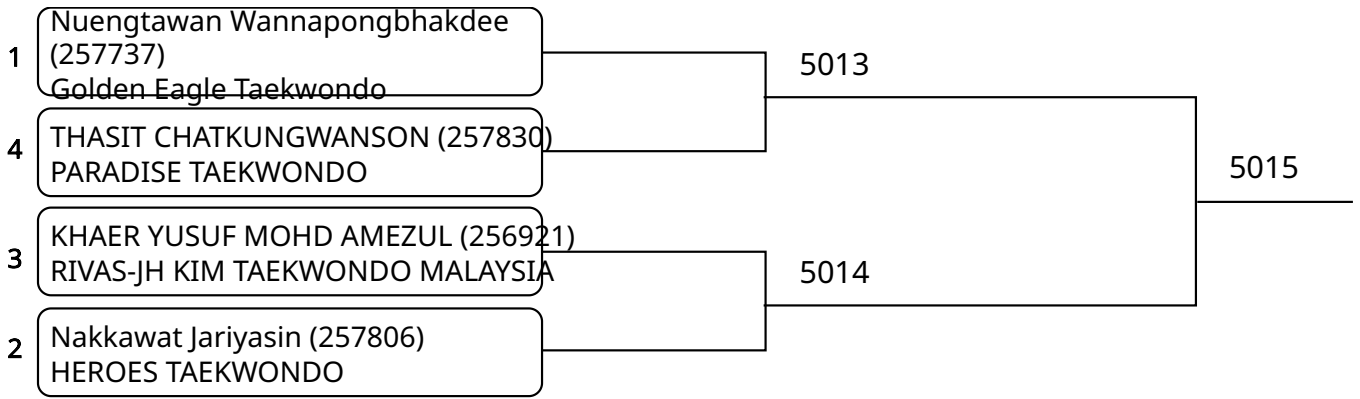

Poomsae Individual (B)Yellow Belt 9-10Yrs Female G1 (entries: 3)

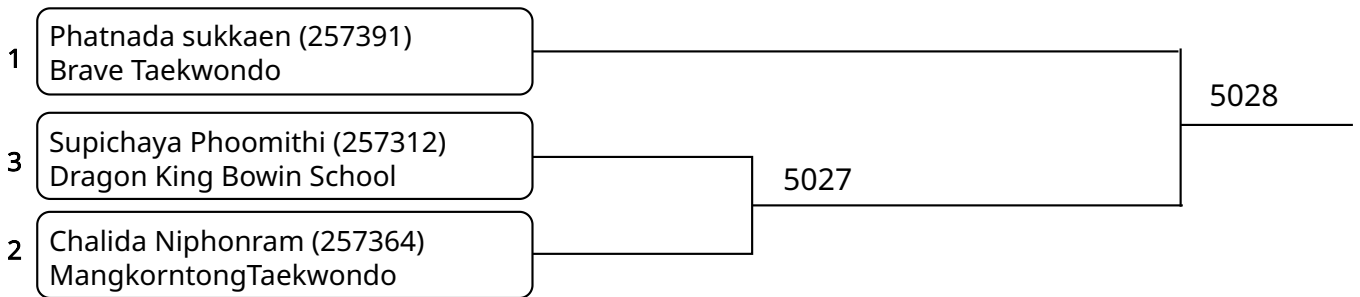

Poomsae Individual (B)Yellow Belt 9-10Yrs Female G2 (entries: 3)

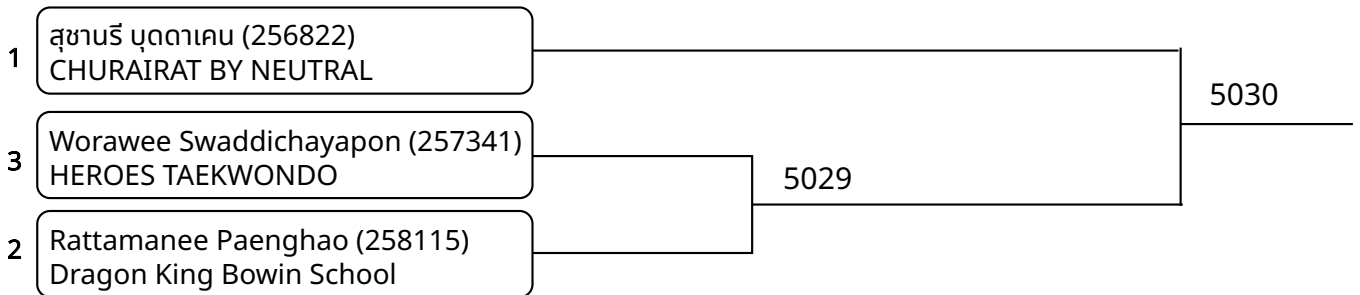

Poomsae Individual (B)Yellow Belt 9-10Yrs Male (entries: 3)

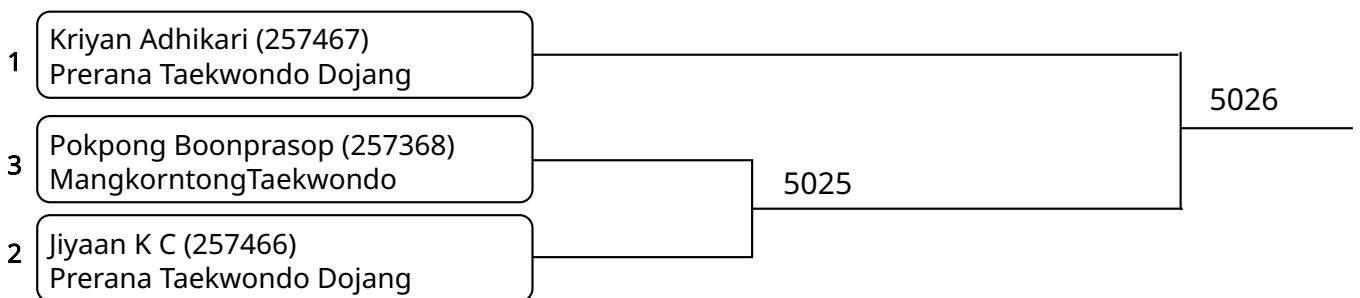



Poomsae Individual (C)Green Belt 11-12Yrs Female G1 (entries: 3)

1	Walaipan Sukho (257537) MangkorntongTaekwondo	5064
3	SOPISTHA CHANTO (257854) HEROES TAEKWONDO	
2	Nathalia Margareth Velasco (257486) Dragon Heart Taekwondo Academy Gensan	

Poomsae Individual (C)Green Belt 11-12Yrs Female G2 (entries: 3)

1	Phatcharakamon Taengthiang (257432) Nachapa Taekwondo	5066
3	Kanokwan Yenprayoon (257869) MONKEYS TAEKWONDO	
2	SIRINAPA BOONMARK (257325) HEROES TAEKWONDO	

Poomsae Individual (C)Green Belt 11-12Yrs Male (entries: 3)

1	Khanakorn Rattanthanakitsakorn (257552) New Kick Taekwondo	5062
3	Shreeyash Tiwari (256909) SITAPAILA TAEKWONDO DOJANG	
2	NATTHAWAT VORAVIWAT (258063) HEROES TAEKWONDO	

Poomsae Individual (C)Green Belt 12-14Yrs Female (entries: 2)

1	Suphakan Chitchutrakun (257433) Nachapa Taekwondo	5069
2	Georgina Kelly (254819) LCA TAEKWONDO BURIRAM	

Poomsae Individual (C)Green Belt 12-14Yrs Male (entries: 1)

1	Aarjan Subedi (257462) Prerana Taekwondo Dojang	5068	Winner by Default
---	--	------	-------------------





Poomsae Individual (C)Green Belt 15-17Yrs Female (entries: 4)

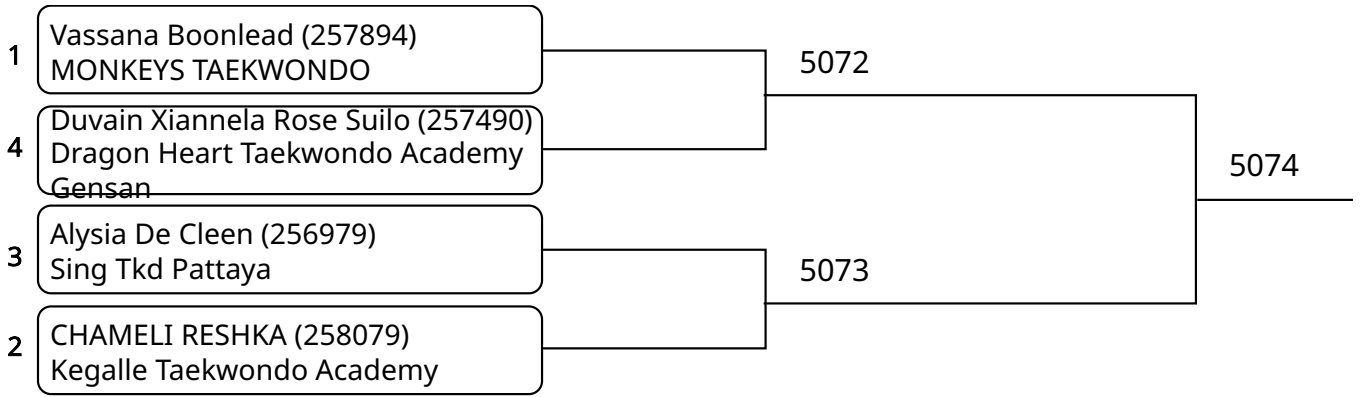

Poomsae Individual (C)Green Belt 15-17Yrs Male (entries: 1)

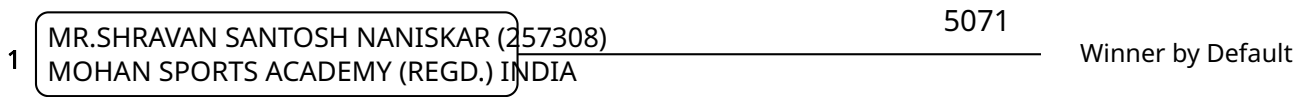

Poomsae Individual (C)Green Belt 5-6Yrs Male (entries: 2)

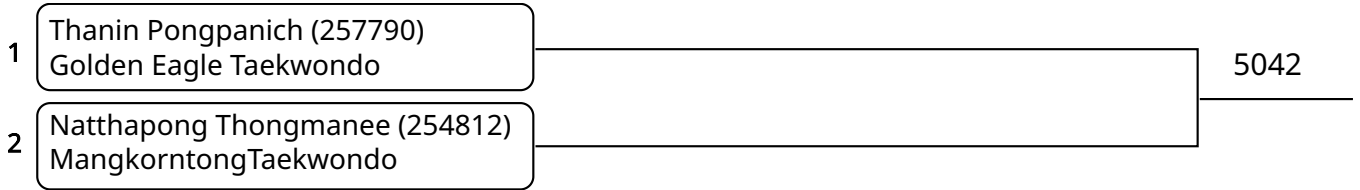

Poomsae Individual (C)Green Belt 7-8Yrs Female (entries: 4)

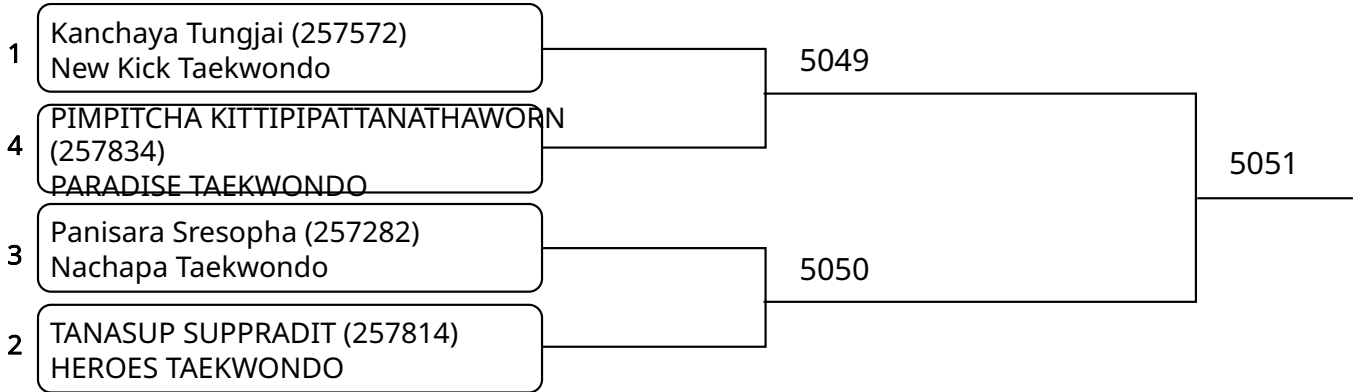

Poomsae Individual (C)Green Belt 7-8Yrs Male G1 (entries: 3)

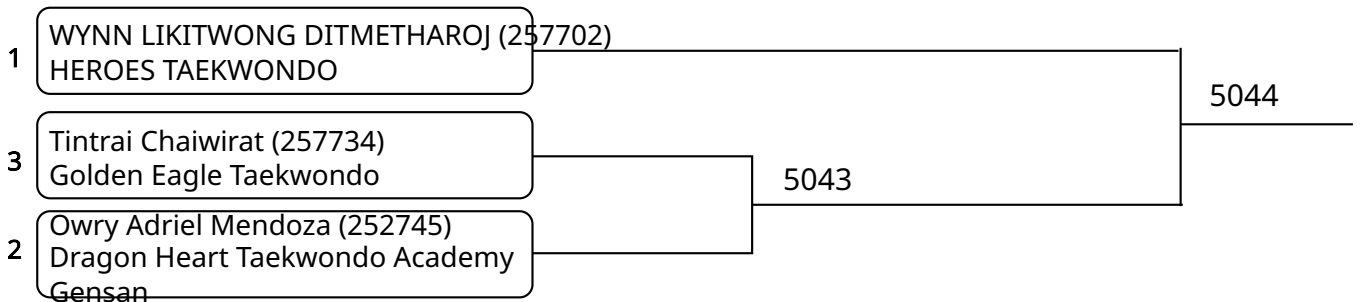



Poomsae Individual (C)Green Belt 7-8Yrs Male G2 (entries: 3)

1	Piyapong Pinatano (257678) New Kick Taekwondo	5046
3	Paraphu Iampiya (257875) FIGHTING FAMILY	
2	POW LIKITWONG (257713) HEROES TAEKWONDO	

Poomsae Individual (C)Green Belt 7-8Yrs Male G3 (entries: 3)

1	NONTAPAT JITCHANVITIT (257829) HEROES TAEKWONDO	5048
3	CHAIYAPAT THAMMARAT (257839) HEROES TAEKWONDO	
2	CHATCHAWEE PATTANAPAISAL (257846) PARADISE TAEKWONDO	

Poomsae Individual (C)Green Belt 9-10Yrs Female G1 (entries: 3)

1	THALINRAT SRISANGRAT (257698) HEROES TAEKWONDO	5057
3	สุชาตรี บุคตาเคน (256823) CHURAIRAT BY NEUTRAL	
2	Rosina Manners (254834) LCA TAEKWONDO BURIRAM	

Poomsae Individual (C)Green Belt 9-10Yrs Female G2 (entries: 3)

1	Pun Leepakpreeda (257760) Golden Eagle Taekwondo	5059
3	KANYAKORN PRAPAKORNSAKUN (257813) HEROES TAEKWONDO	
2	Chalida Niphonram (257365) MangkorntongTaekwondo	

Poomsae Individual (C)Green Belt 9-10Yrs Male G1 (entries: 3)

1	NARUBODIN THAMMARAT (257724) HEROES TAEKWONDO	5054
3	Phil Andrei Chard Suilo (256920) Dragon Heart Taekwondo Academy Gensan	
2	Paphawin Jongjarussang (258048) New Kick Taekwondo	





Poomsae Individual (C)Green Belt 9-10Yrs Male G2 (entries: 2)

1	Chayakrit Chaimang (257396) MangkorntongTaekwondo	5055
2	PUNN LIKITWONG (257711) HEROES TAEKWONDO	

Poomsae Individual (D)Blue Belt 11-12Yrs Female (entries: 3)

1	NATNICHA JUWIWAT (257581) New Kick Taekwondo	5084	
3	ALMA VANYA THACKRAY (257503) RIVAS JH KIM TAEKWONDO INDONESIA		5083
2	Walaipan Sukho (257538) MangkorntongTaekwondo		

Poomsae Individual (D)Blue Belt 12-14Yrs Female (entries: 1)

1	Gabrielle Conchada (257475) JBM TAEKWONDO ACADEMY PHILIPPINES	5086	Winner by Default
---	--	------	-------------------

Poomsae Individual (D)Blue Belt 18Yrs+ Male (entries: 1)

1	Suraj Ghimire (257261) SITAPAILA TAEKWONDO DOJANG	5087	Winner by Default
---	--	------	-------------------

Poomsae Individual (D)Blue Belt 5-6Yrs Male (entries: 2)

1	Thanin Pongpanich (257791) Golden Eagle Taekwondo	5075
2	Natthapong Thongmanee (254813) MangkorntongTaekwondo	

Poomsae Individual (D)Blue Belt 7-8Yrs Female (entries: 1)

1	APISADA SOPHON (257792) HEROES TAEKWONDO	5077	Winner by Default
---	---	------	-------------------

Poomsae Individual (D)Blue Belt 7-8Yrs Male (entries: 1)

1	ACHIRA JUNKUN (257967) HEROES TAEKWONDO	5076	Winner by Default
---	--	------	-------------------

Poomsae Individual (D)Blue Belt 9-10Yrs Female (entries: 1)

1	NITTHITA SUNGKAEW (256814) CHURAIRAT BY NEUTRAL	5081	Winner by Default
---	--	------	-------------------





Poomsae Individual (D)Blue Belt 9-10Yrs Male (entries: 4)

1	Worapak Somtua (257989) RSR CHONBURI TEAM	5078	
4	Thanapat Junseela (257554) New Kick Taekwondo		5080
3	THANAWAT KATAKUN (257343) HEROES TAEKWONDO	5079	
2	Thakrit Tungjai (257579) New Kick Taekwondo		

Poomsae Individual (E)Brown Belt 11-12Yrs Female (entries: 2)

1	NABILA BUDWI (257504) RIVAS JH KIM TAEKWONDO INDONESIA	5090
2	SASINAT NGAMSAKULROONGROJ (256932) CHURAIRAT BY NEUTRAL	

Poomsae Individual (E)Brown Belt 12-14Yrs Female (entries: 1)

1	DIANE ANG JIA YI (256918) RIVAS-JH KIM TAEKWONDO MALAYSIA	5091	Winner by Default
---	--	------	-------------------

Poomsae Individual (E)Brown Belt 18Yrs+ Male (entries: 1)

1	KENT BIANCHINI CHEN (257505) RIVAS JH KIM TAEKWONDO INDONESIA	5092	Winner by Default
---	--	------	-------------------

Poomsae Individual (E)Brown Belt 9-10Yrs Female (entries: 1)

1	NITTHITA SUNGKAEW (256815) CHURAIRAT BY NEUTRAL	5089	Winner by Default
---	--	------	-------------------

Poomsae Individual (E)Brown Belt 9-10Yrs Male (entries: 2)

1	PHUN WANKAEW (257704) HEROES TAEKWONDO	5088
2	Ariyaphon Wichian (257559) New Kick Taekwondo	





Poomsae Individual (F)Red Belt 11-12Yrs Female (entries: 3)

1	RUTHAIPHAT SUKHUMVITHAYA (257264) CHURAIRAT BY NEUTRAL	5098
3	PORNCHANOK YORDKHWAN (257810) HEROES TAEKWONDO	
2	Pimnara Kupakrapinyo (257748) Golden Eagle Taekwondo	

Poomsae Individual (F)Red Belt 12-14Yrs Female (entries: 1)

1	SASINAT NGAMSAKULROONGROJ (257388) CHURAIRAT BY NEUTRAL	5101	Winner by Default
---	--	------	-------------------

Poomsae Individual (F)Red Belt 12-14Yrs Male (entries: 1)

1	KITIPHONG WATTANASAK (257809) HEROES TAEKWONDO	5100	Winner by Default
---	---	------	-------------------

Poomsae Individual (F)Red Belt 18Yrs+ Male (entries: 1)

1	Paras Bhandari (256908) SITAPAILA TAEKWONDO DOJANG	5102	Winner by Default
---	---	------	-------------------

Poomsae Individual (F)Red Belt 7-8Yrs Female (entries: 2)

1	NITTHITA SUNGKAEW (250943) CHURAIRAT BY NEUTRAL	5094
2	MINNARA PITAKPATTANASAKUL (257794) HEROES TAEKWONDO	

Poomsae Individual (F)Red Belt 7-8Yrs Male (entries: 1)

1	KIYAN ANSARI (257822) HEROES TAEKWONDO	5093	Winner by Default
---	---	------	-------------------

Poomsae Individual (F)Red Belt 9-10Yrs Female (entries: 1)

1	LYNLADA PITAKPATTANASAKUL (257793) HEROES TAEKWONDO	5096	Winner by Default
---	--	------	-------------------

Poomsae Individual (F)Red Belt 9-10Yrs Male (entries: 1)

1	ARTHITCHARN JIRAROJCHAROEN (256821) CHURAIRAT BY NEUTRAL	5095	Winner by Default
---	---	------	-------------------





Poomsae Individual (G)Poom/Black Belt 11-12Yrs Female (entries: 2)

1	UNCHAKET PANYAKORNKHEMAKUL (257439) CHURAIRAT BY NEUTRAL	5113
2	Pimnara Kupakrapinyo (257749) Golden Eagle Taekwondo	

Poomsae Individual (G)Poom/Black Belt 11-12Yrs Male (entries: 1)

1	Tanaphat Panapongpaisan (257747) Golden Eagle Taekwondo	5112	Winner by Default
---	--	------	-------------------

Poomsae Individual (G)Poom/Black Belt 12-14Yrs Female (entries: 2)

1	EVANGELISTA YEAP NING (256919) RIVAS-JH KIM TAEKWONDO MALAYSIA	5117
2	Nattanan Panapongpaisan (257743) Golden Eagle Taekwondo	

Poomsae Individual (G)Poom/Black Belt 12-14Yrs Male (entries: 1)

1	CHATCHANUN LARPCHAROENSUK (256809) CHURAIRAT BY NEUTRAL	5116	Winner by Default
---	--	------	-------------------

Poomsae Individual (G)Poom/Black Belt 15-17Yrs Female (entries: 4)

1	Artitaya Dissayaton (257879) MONKEYS TAEKWONDO	5119	5121
4	Nattanan Panapongpaisan (257744) Golden Eagle Taekwondo		
3	Thanison Khanmueng (257868) MONKEYS TAEKWONDO	5120	
2	วิจิตร สี่อุดม (256824) CHURAIRAT BY NEUTRAL		

Poomsae Individual (G)Poom/Black Belt 15-17Yrs Male (entries: 2)

1	SINGHA THUMMANUSSORN (257923) CHURAIRAT BY NEUTRAL	5122
2	THAPARAT APIPONGPAT (257461) NANGRONG TKD.	





Poomsae Individual (G)Poom/Black Belt 18Yrs+ Male (entries: 2)

1	Bidhan Pandey (257463) Prerana Taekwondo Dojang	5124
2	Dilip Khadka (257464) Prerana Taekwondo Dojang	

Poomsae Individual (G)Poom/Black Belt 7-8Yrs Female (entries: 2)

1	NAWAWAN DECHANUNT (257847) HEROES TAEKWONDO	5104
2	Malinda Kunatorn (257740) Golden Eagle Taekwondo	

Poomsae Individual (G)Poom/Black Belt 7-8Yrs Male (entries: 1)

1	TEETAT MUANGPAN (257677) New Kick Taekwondo	5103	Winner by Default
---	--	------	-------------------

Poomsae Individual (G)Poom/Black Belt 9-10Yrs Female (entries: 1)

1	Malinda Kunatorn (257753) Golden Eagle Taekwondo	5109	Winner by Default
---	---	------	-------------------

Poomsae Individual (G)Poom/Black Belt 9-10Yrs Male (entries: 5)

1	CHAYARNON LARPHAROENSUK (256808) CHURAIRAT BY NEUTRAL	5106	5108
5	PUNNAWAT COTAMA (256817) CHURAIRAT BY NEUTRAL		
4	NG ZI RYU (256923) RIVAS-JH KIM TAEKWONDO MALAYSIA	5105	
3	CHANAKAN SATHIPANYA (257679) New Kick Taekwondo	5107	
2	Manutsawin Jirapatcharavoranon (257741) Golden Eagle Taekwondo		

Poomsae Pair (B)Yellow Belt 11-12Yrs Female (entries: 2)

1	Rattikan Yomjinda (257980) MONKEYS TAEKWONDO	5037	Winner by Default
---	---	------	-------------------

Poomsae Pair (B)Yellow Belt 7-8Yrs Female (entries: 2)

1	MAYU KAWINTIPPAYAKUL (257557) New Kick Taekwondo	5023	Winner by Default
---	---	------	-------------------





Poomsae Pair (B)Yellow Belt 7-8Yrs Male (entries: 2)

1	Nuengtawan Wannapongbhakdee (257738) Golden Eagle Taekwondo	5022	Winner by Default
---	--	------	-------------------

Poomsae Pair (B)Yellow Belt 9-10Yrs Female (entries: 2)

1	Paphatsara Chuenlosang (257876) MONKEYS TAEKWONDO	5031	Winner by Default
---	--	------	-------------------

Poomsae Pair (C)Green Belt 7-8Yrs Male (entries: 2)

1	CHATCHAWEE PATTANAPAISAL (257842) PARADISE TAEKWONDO	5052	Winner by Default
---	---	------	-------------------

Poomsae Pair (C)Green Belt 9-10Yrs Female (entries: 2)

1	Pun Leepakpreeda (257761) Golden Eagle Taekwondo	5060	Winner by Default
---	---	------	-------------------

Poomsae Pair (D)Blue Belt 11-12Yrs Female (entries: 2)

1	ALMA VANYA THACKRAY (257506) RIVAS JH KIM TAEKWONDO INDONESIA	5085	Winner by Default
---	--	------	-------------------

Poomsae Pair (D)Blue Belt 9-10Yrs Female (entries: 2)

1	SUCHANAREE BUDAKEN (256927) CHURAIRAT BY NEUTRAL	5082	Winner by Default
---	---	------	-------------------

Poomsae Pair (F)Red Belt 11-12Yrs Male (entries: 2)

1	ARTHITCHARN JIRAROJCHAROEN (256929) CHURAIRAT BY NEUTRAL	5099	Winner by Default
---	---	------	-------------------

Poomsae Pair (F)Red Belt 12-14Yrs Male (entries: 2)

1	KITIPHONG WATTANASAK (257913) HEROES TAEKWONDO	5070	Winner by Default
---	---	------	-------------------

Poomsae Pair (G)Poom/Black Belt 11-12Yrs Female (entries: 2)

1	RUTHAIPHAT SUKHUMVITHAYA (257386) CHURAIRAT BY NEUTRAL	5115	Winner by Default
---	---	------	-------------------





Poomsae Pair (G)Poom/Black Belt 11-12Yrs Male (entries: 2)

1	SINGHA THUMMANUSSORN (257384) CHURAIRAT BY NEUTRAL	5114	Winner by Default
---	---	------	-------------------

Poomsae Pair (G)Poom/Black Belt 12-14Yrs Female (entries: 2)

1	Nattanan Panapongpaisan (257745) Golden Eagle Taekwondo	5118	Winner by Default
---	--	------	-------------------

Poomsae Pair (G)Poom/Black Belt 9-10Yrs Female (entries: 2)

1	Malinda Kunatorn (257751) Golden Eagle Taekwondo	5110	Winner by Default
---	---	------	-------------------

Poomsae-Team3 (B)Yellow Belt 7-8Yrs Male (entries: 3)

1	TRYN KINGKACHEE (257719) HEROES TAEKWONDO	5024	Winner by Default
---	--	------	-------------------

Poomsae-Team3 (C)Green Belt 11-12Yrs Female (entries: 3)

1	KANYAKORN PRAPAKORNSAKUN (257910) HEROES TAEKWONDO	5067	Winner by Default
---	---	------	-------------------

Poomsae-Team3 (G)Poom/Black Belt 15-17Yrs Female (entries: 3)

1	Thanison Khanmueng (257871) MONKEYS TAEKWONDO	5123	Winner by Default
---	--	------	-------------------

Poomsae-Team3 (G)Poom/Black Belt 9-10Yrs Male (entries: 3)

1	CHAYARNON LARPHAROENSUK (256810) CHURAIRAT BY NEUTRAL	5111	Winner by Default
---	--	------	-------------------

